

TECHNICAL MANUAL

- 143 Installation by formats
- 159 Installation guide
- 195 FAQ´s (Frecuantly asked questions))
- 197 Standards and quality certificates

INSTALLATION BY FORMATS

- 144 TB-Flat roof tile **(new)**
- 146 TB-4 Quattro® roof tile
- 148 TB-12® roof tile
- 150 TB-10 roof tile
- 152 Alicantina Flat roof tile
- 154 Curved roof tiles (40x19, 40x15,
45x20, Celler® 50x21 & 25x12)
- 154 Kastor roof tile
- 156 Escama roof tile
- 157 Escama Royal roof tile **(new)**

TB-Flat



Installation details

See formats and finishing accessories in page 108

End Cap

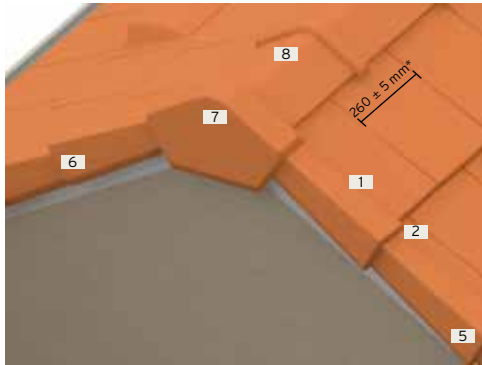

Ridge line

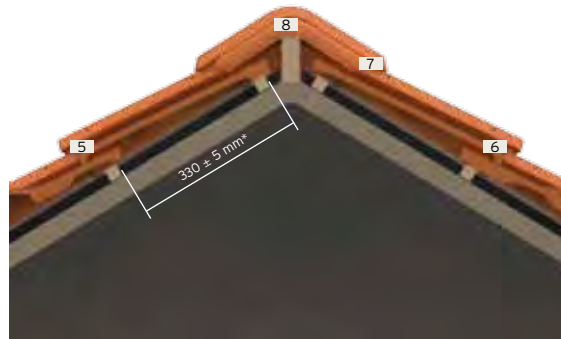

Monopitch

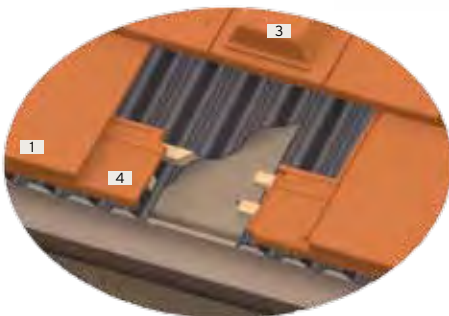
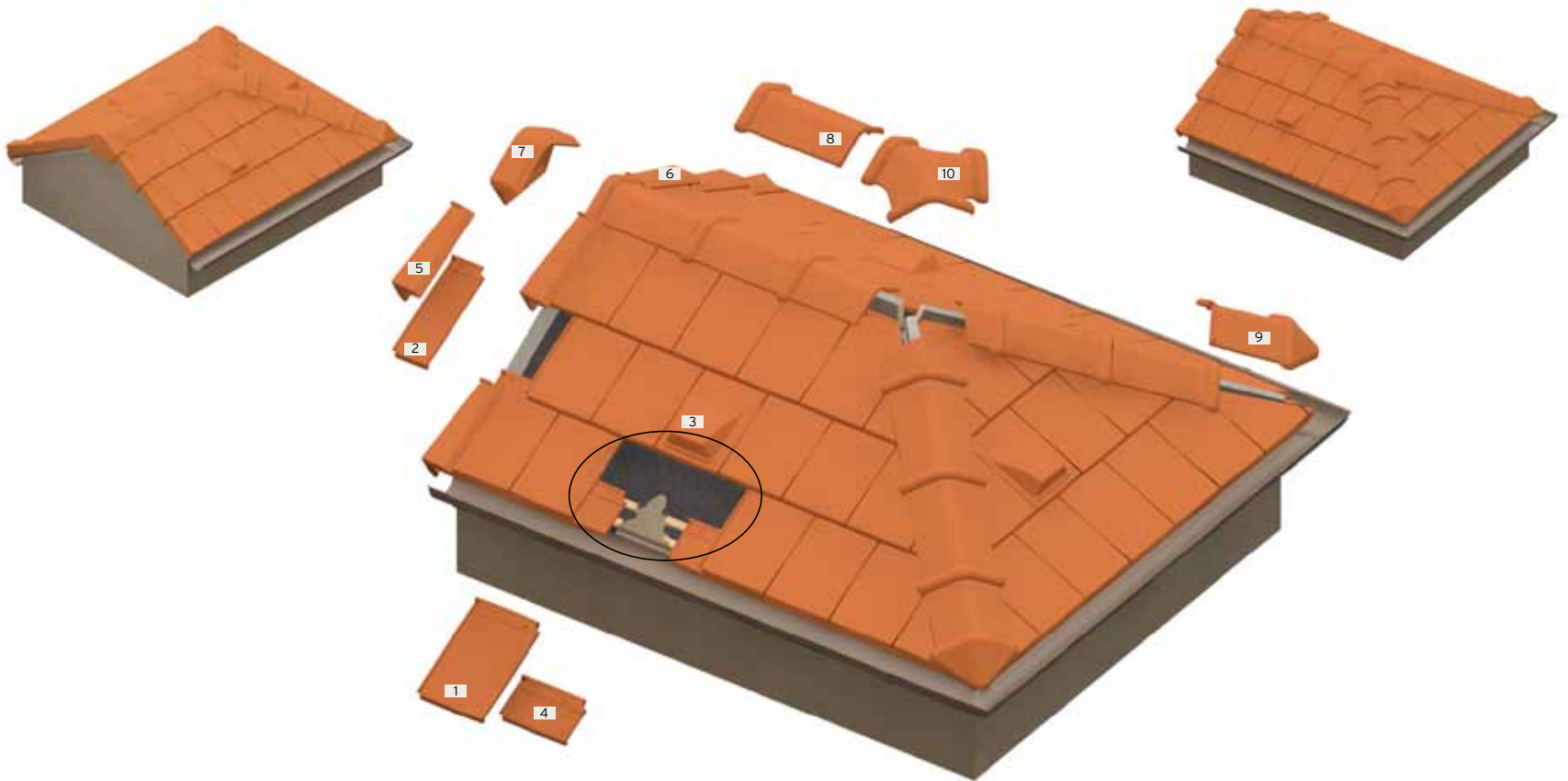

Waterproofing detail
(Asphalt board)

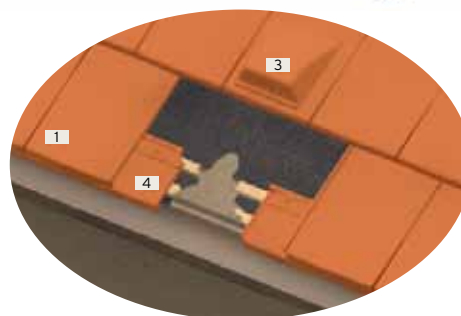

Waterproofing detail
(asphalt membrane)

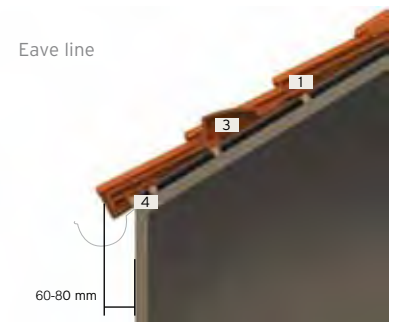

Eave line

* It is necessary to check the useful length on site

Installation

See AutoCAD files on www.tejasborja.com

SUPPORT

This format can be placed on any type of structure, on mortar base or with wooden or metallic battens (RECOMMENDED) or continuous waterproof decking.

In any case, the deck surface has to be perfectly levelled. Special attention should be paid to inclined decks by smoothing down and levelling them with finishing mortar.

ROOF TILE INSTALLATION

The installation is similar to the Alicantina Flat roof tile. In order to achieve a proper installation, start along the eave line, from right to left, in conformity with the direction of the side fittings, so that the next roof tile fits over the one previously placed. Start this operation using the STARTER TB-FLAT ROOF TILE (4), placing the first course of roof tiles on top of it, even with the eave line. After this first line (the eaves), place the remaining tiles one on top of the other in ascending and parallel course.

Keep in mind that this format of roof tile is recommended to be installed in discontinuous joints or joined in "herringbone" fashion (in stepped course way), so that the HALF TB-FLAT ROOF TILE (2) shall be used on the left and right sides of the deck.

If the installation is done in continuous joints, the half roof tile will not be necessary. Once the roof tiles are placed, finish the sides of the roof surface with TB-FLAT UNIVERSAL EDGE- LEFT HOLES (5) and the TB-FLAT UNIVERSAL EDGE- RIGHT HOLES (6).

Finally, finish the ridge line with ANGULAR RIDGE (8). At the starting position of the hip line, use the ANGULAR HIP STARTER (9) and at the end of the ridge line, the TB-FLAT STRAIGHT END CAP (7). When necessary, the ANGULAR 3 WAYS (10) shall be used. In case of mono-pitch the UNIVERSAL ANGULAR EDGE (11) shall be used placing it under the ridge.

FIXING

- WITH MORTAR:

Use the minimum quantity of mortar necessary to fix the ceramic pieces, and always do so in a way that allows the correct ventilation of all of the roofing pieces*. We recommend the use of mortars (preferably waterproof) with a 1:2:10 ratio dosage; that is, for every m³ of dry sand, use 200 kg of hydraulic lime and 100 kg of cement.

- WITH BATTENS (This is the recommended type of installation):

Battens made of wood, metal or PVC can be used. Place them perpendicular to the maximum pitch line, spacing each of them at every 2 meters to allow the ventilation through the underside part of the tiles.

First place the counter battens for the STARTER TB-FLAT ROOF TILE (4) between 8 and 10 cm. from the eave of the support; the roof tile shall hang out from 6 to 8 cm. Place the counter batten from the first course of TB-FLAT ROOF TILE in such a way that it overlaps and is even with the STARTER TB-FLAT ROOF TILE (4) and is at a distance of 23.5 cm from the first batten; in this way, you create the first course of tiles (eave line). Finally, install the rest of the tiles with a batten interval of 33 cm. + 0.5 cm - 0.5 cm. (Always verify these values during installation).

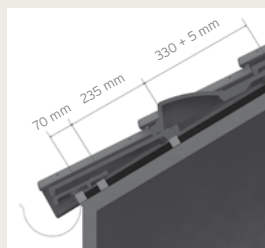

* According to TEJAS BORJA's specifications

Keep in mind that in order to fix the sides, the counter battens are prepared parallel to the maximum pitch line and perpendicular to the eave line.

To fix the ceramic pieces use nails or self drilling screws made of tempered and galvanized steel and washers for fixing them with a hammer or gun, or polyurethane foam or paste specially designed to fix tiles. Finally, seal all holes*.

VENTILATION

The underside of the tiles should be appropriately ventilated to ensure the correct preservation of the roof and to avoid the formation of condensation.

Air should be allowed to enter through the eaves, which should not be sealed or closed off with mortar. The same goes for roof valleys if there are any.

A minimum of 1 TB-FLAT VENTILATION ROOF TILE (3) for every 5 m² should be placed when using continuous structure (attaching with mortar), and 1 tile for every 10 m² when using discontinuous structure (attaching with battens) and with a minimum of 4 ventilation tiles per roof surface, two on the low side and one on the high side.

Air should be able to pass through the ridge line and hip line; be sure not to close these off with mortar, use VENTILATED ENCLOSURES FOR RIDGE.

To prevent the obstruction of air flow throughout the entire roof, use the minimum amount of mortar to fix the ceramic pieces (attaching with mortar), or interrupt the placement of the laths at two meter intervals (dry fixing) ensuring so the minimum air flow under tile of 30 mm

See more information in page 176.

PITCH

Because of its flat and decorative design, the TB-Flat roof tile is recommended on pitches greater than 60% so that the differentiating aesthetic value of the roof is not lost.

VERY IMPORTANT:

TB-Flat roof tile is a product especially designed to decorate roofs. It will be necessary to waterproof the entire surface for all pitches. Its design implies that TB-Flat surface is no uniformly flat. Each tile can vary up to 8 mm along the horizontal plane (according to UNE standard 1304), so we recommend combining the contents of each pallet to obtain a uniform roof appearance.

LONG ROOF SURFACES

For roof lengths greater than 12 m, an intermediary gutter shall be used. Always waterproof the entire roof*.

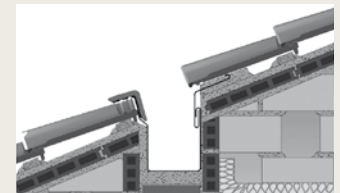

MAINTENANCE

For a full conservation of the roof we recommend a regular inspection of it, removing moss, lichen, plants or any strange body that impedes the proper functioning of the roof.

TEJAS BORJAS' products are in agreement with the EU regulations, conforming to our certificates and documentation published in our catalogue and our website.

The method of roof tile placement is the responsibility of the installer. It should follow TEJAS BORJA's technical specifications.

TB-4 Quattro®



Installation details

See formats and finishing accessories in page 110

Ridge line

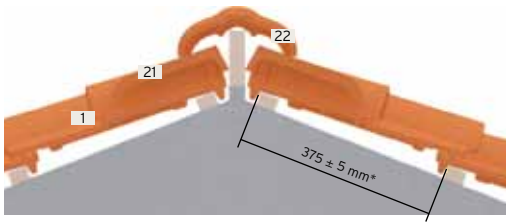

Monopitch

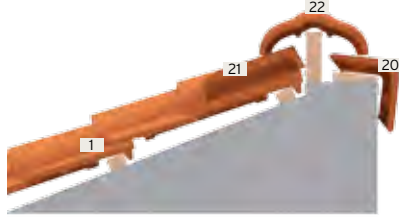

3-Ways

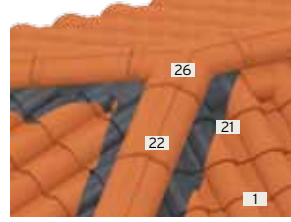

Hip line ventilation



LH 517 section

TB-4® curved edges and Universal cover + curved end cap

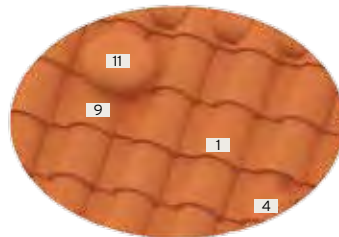

Ventilation cap option (Diagram B)

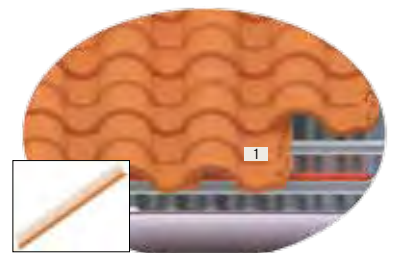

LH 521

Plastic bird barrier (Diagram C)

TB-4® curved edges and Universal circular curved end cap

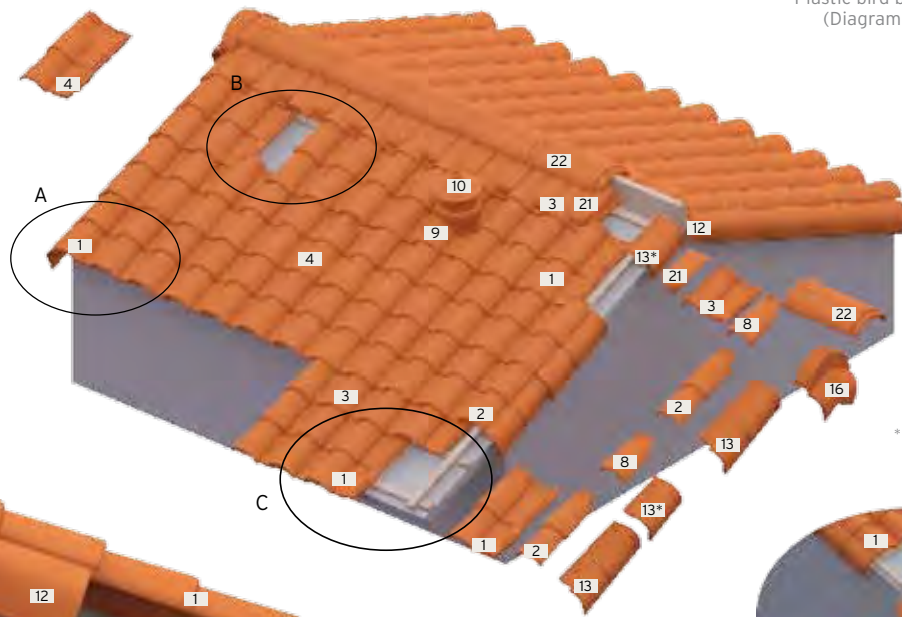
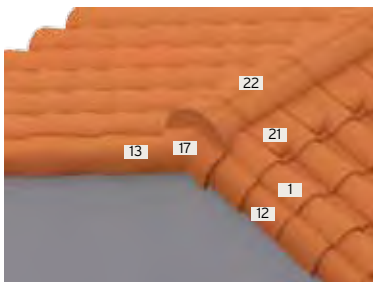

* Cut on site

Universal straight edges and Universal cover + straight end cap



Eave line

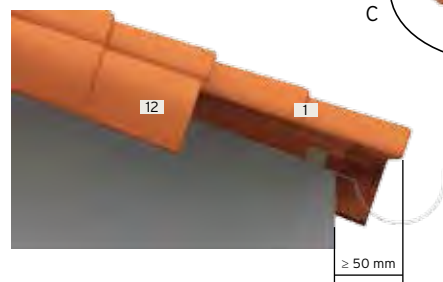

Eave line with TB-4® Pan Decocurva® overhanging

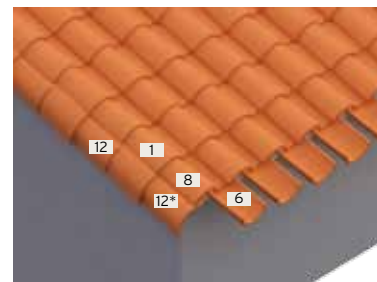

Eave line with TB-4® eave closure

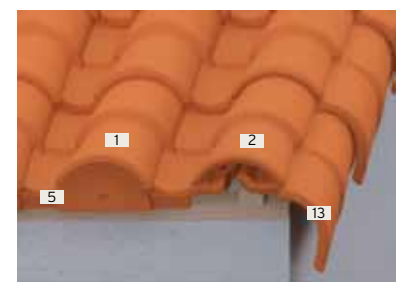
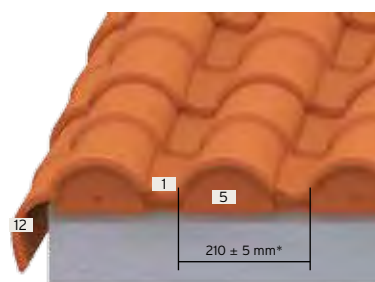

Decocurva® option (Diagram A)

Eave line

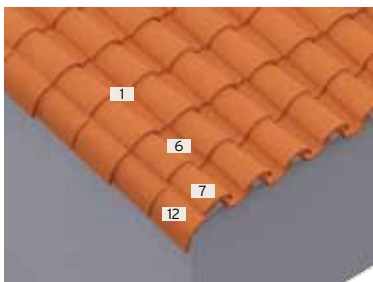

It is necessary to check the useful length on site, as per valid standards

Installation

See AutoCAD files on www.tejasborja.com

SUPPORT

This format can be placed on any type of structure, on mortar base or with wooden, metallic or PVC battens (RECOMMENDED) or continuous waterproof decking.

In any case, the deck surface has to be perfectly levelled. Special attention should be paid to inclined decks by smoothing down and levelling them with finishing mortar.

ROOF TILE INSTALLATION

Start mounting the roof tiles at the left bottom corner of the deck. First the LEFT EDGE (12 or 14) is placed and then all the tiles of the eave line; to guide the placing use a set square, and draw perpendiculars from the ridge line. Then the tiles are placed from bottom to top and from left to right, checking that the roof tiles are correctly aligned. End in the right side with the RIGHT EDGE (13 or 14) and the HALF TB-4® ROOF TILE (2). The use of the HALF TB-4® ROOF TILE (2) enables us to avoid the need of the longitudinal cut of the roof tile. When the dimensions of the deck require it, the ONE HALF TB-4® ROOF TILE (3) shall be used.

The EDGES protect the side wall plaster from dampness, providing the vertexes of the deck with an efficient protection, as well as giving a more aesthetic finishing.

The ridge line and hip line must be completed with RIDGES, RIDGES ACCESSORIES (22 or 23 or see page nº 128 for accessories) and UNIVERSAL UNDER RIDGE (21), in order to guarantee better covering and better aesthetic finishing. At the end of the ridge line, the END CAP (16, 17 or 19) is placed and, SENSE CHANGEMENT, 3 WAYS (26) or 4 WAYS pieces are used, when needed. At the starting position of the hip line, the HIP STARTER (25) is placed. In case of monopitch the UNIVERSAL ANGULAR EDGE (11) shall be used placing it under the ridge.

When the eave line is solved with DECOCURVA® pieces, these have to be placed according to the specific constructive details for TB-4 Quattro® roof tile, or in general, according to the recommendations from Installation guide, page 174.

FIXING

- WITH BATTENS (This is the recommended type of installation):
Wood, metal or PVC battens can be used. Place them perpendicular to the maximum pitch line, spacing each piece every 2 meters to allow the ventilation through the underside part of the tiles, ensuring a minimum air passing thru of 30 mm.

Keep in mind that in order to fix of the edges, the counter battens are prepared, parallel with the maximum pitches line and perpendicular to the eave line.

To fix the ceramic pieces use nails or self drilling screws made of tempered and galvanized steel and washers for fixing them with a hammer or gun, or polyurethane foam or paste specially designed to fix tiles. Finally, seal all holes*.

- WITH MORTAR:

Use the minimum quantity of mortar necessary to fix the ceramic pieces, and always do so in a way that allows the correct ventilation of all of the roofing pieces. We recommend the use of mortars (preferably waterproof) with a 1:2:10 ratio dosage; that is, for every m³ of dry sand, use 200 kg of hydraulic lime and 100 kg of cement.

VENTILATION

The underside part of the tiles must be suitably ventilated to guarantee the adequate conservation of the roof, to prevent the formation of condensations and to prevent the ceramic pieces getting to the degree of saturation, issues that cause serious problems, especially in climatic zones with a high risk of frosts, throughout time.

Always provide an air entrance, an under tile air flow for the entire surface and an air exit on the highest part of the roof, usually to the ridge line and hip line (on each face of the deck).

The air entrance is done on the eave line, without closing it off with mortar, using the plastic bird barrier or the TB-4® EAVE CLOSURE (5). The same goes for the valleys, if there are any.

The air flow over the entire roof face it's obtained placing 1 TB-4® VENTILATION ROOF TILE for every 5 m², for a continuous deck (fixing with mortar) and 1 tile for every 10 m² for discontinuous deck (fixing with battens). Minimum 4 ventilation tiles are needed, two in the lower part of the roof and two in the upper part.

The air exit through the ridge line and hip line; be sure not to close these off with mortar, while placing RIDGES (22 or 23) (see page 128 for accessories) and under ridges (21). Use VENTILATED ENCLOSURES FOR RIDGE LINE.

To prevent the obstruction of air flow throughout the entire roof, use the minimum amount of mortar to fix the ceramic pieces (attaching with mortar), or interrupt the placement of the laths at two meter intervals (dry fixing) ensuring so the minimum air flow under tile of 30 mm.

See more information in page 176.

PITCH

Depending of the length of the deck and the geographical area or the place where it is situated (depending on wind, rain, altitude, nearness to the sea, etc.)

PITCH PANNEL (according to the roof length and geographical area)

	up to 6,5m.	from 6,5 to 9,5m.	from 9,5 to 12m.
Protected place	30%	33%	35%
Normal place	33%	36%	40%
Exposed place	40%	43%	50%

Check with us for roofs longer than 12m.

LONG ROOF SURFACES

For roof lengths greater than 12 m, an intermediary gutter shall be used or waterproof the entire roof surface*.



MAINTENANCE

For a full conservation of the roof we recommend a regular inspection of it, removing moss, lichen, plants or any strange body that impedes the proper functioning of the roof.

TEJAS BORJAS' products are in agreement with the EU regulations, conforming to our certificates and documentation published in our catalogue and our website.

The method of roof tile placement is the responsibility of the installer. It should follow TEJAS BORJA's technical specifications.

* According to TEJAS BORJA's specifications



Installation details

See formats and finishing accessories in page 112

Ridge line

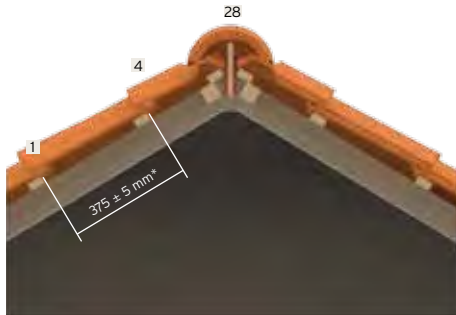

TB-12® curved edges and Universal cover + curved end cap

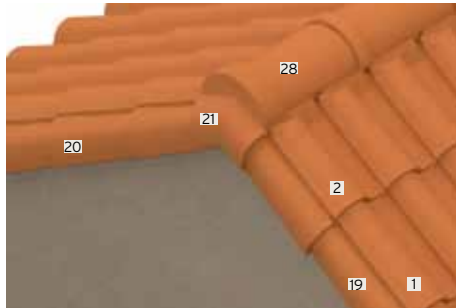

3-Ways



TB-12® Bardelis edges and TB-12® cover + Bardelis end cap



Hip line ventilation

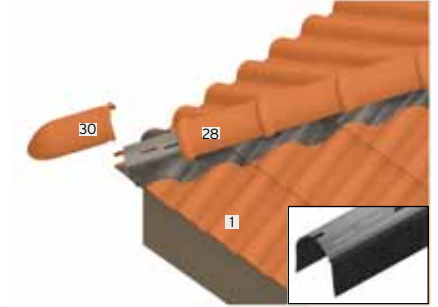

LH 517 section

Universal circular edges and Universal circular straight end cap

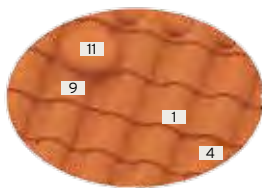
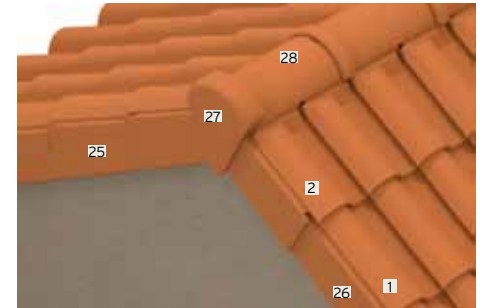

Ventilation cap option (Diagram A)

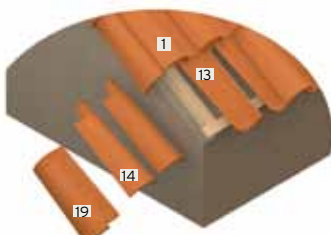

Decocurva® option (Diagram B)

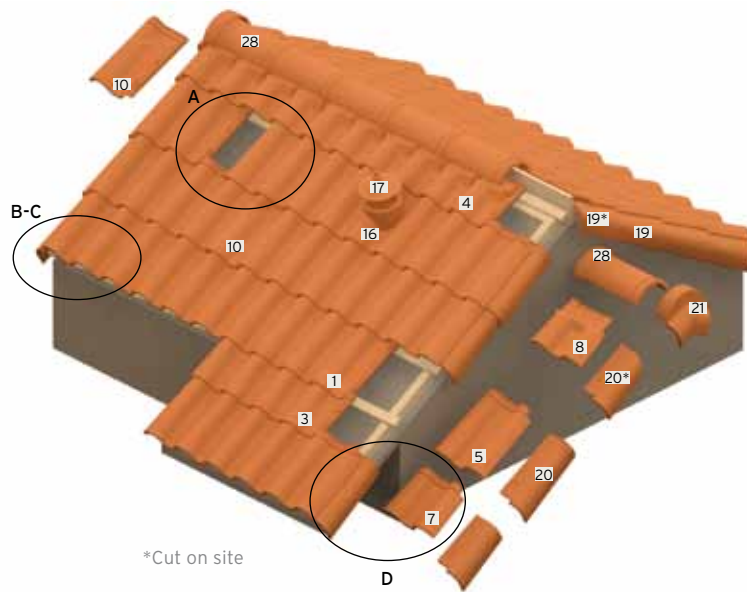

*Cut on site

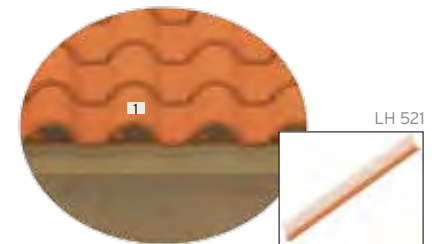

Plastic bird barrier (Diagram C)

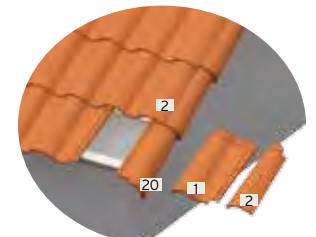

Half TB-12® option (Diagram D)

Eave line

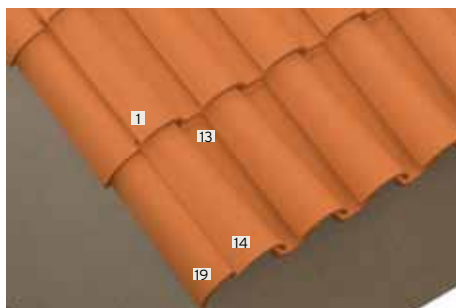

Eave line with TB-12® Pan Decocurva® overhanging

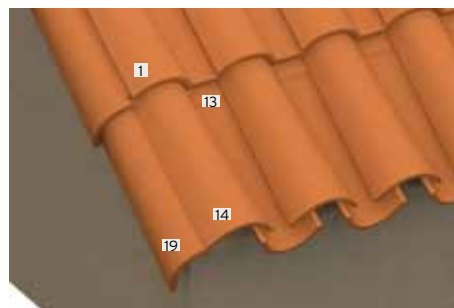

Eave line with TB-12® eave closure

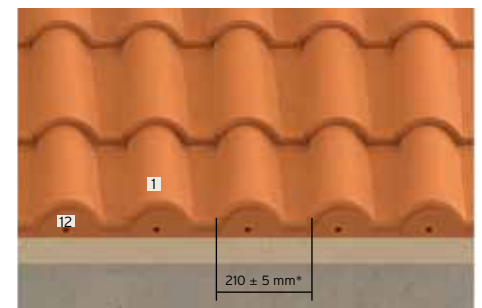

Installation

See AutoCAD files on www.tejasborja.com

SUPPORT

This format can be placed on any type of structure, on mortar base or with wooden, metallic or PVC battens (RECOMMENDED) or continuous waterproof decking.

In any case, the deck surface has to be perfectly levelled. Special attention should be paid to sloping planes decks by smoothing down and levelling them with finishing mortar.

ROOF TILE INSTALLATION

Start placing the roof tiles at the left bottom corner of the deck. First the LEFT EDGE (19, 22 or 26) is placed and then all the tiles of the eave line; to guide the placing use a set square, and draw perpendiculars from the ridge line.

Then the tiles are placed from bottom to top and from left to right, checking that the roof tiles are correctly aligned. End in the right side with the RIGHT EDGE (20, 21 or 27) and the HALF TB-12® ROOF TILE (9) or the TILE AND A HALF TB-12® (5).

The use of the TILE AND A HALF TB-12® and HALF TB-12® ROOF TILE (2) enables us to avoid the need of the longitudinal cut of the roof tile. When the dimensions of the deck require it, the 2/3 TILE AND A HALF TB-12® ROOF TILE (7) shall be used.

The CURVED edges (19 and 20), BARDELIS EDGES (22 and 23) or STRAIGHT EDGES (25 and 26) protect the side wall plaster from dampness, providing the vertexes of the deck with an efficient protection, as well as giving a more aesthetic finishing.

The ridge line and hip line must be completed with ridges accessories (28, 29, 30, 31; see page 128 for accessories) and UNIVERSAL UNDER RIDGE (31), in order to guarantee better covering*. At the end of the ridge line, the UNIVERSAL CURVED END CAP (21), TB-12® BARDELIS END CAP (24) or UNIVERSAL STRAIGHT END CAP (27) shall be placed and SENSE CHANGEMENT (29), 3 WAYS (32) or 4 WAYS pieces are used when needed. At the starting position of the hip line, the HIP STARTER (30) is placed.

*Like a solution for the ridge line, depending on the finishings available, those accessories can be used: ridges accessories (28, 29, 30 and 32, or see page nº 136 for accessories), UNDER RIDGE TB-12® (2), 2/3 UNDER RIDGE TB-12® (4) TILE AND A HALF UNDER RIDGE TB-12® (6) and 2/3 TILE AND A HALF TB-12® (8).

When the eave line is solved with Decocurva® pieces (13 and 14), these have to be placed according to the specific installation details for TB-12® roof tile, or in general, according to the recommendations from Installation guide, page 174.

For this format TB-12® accessories to fix solar energy panels over the roofs are available. See page 138-139 for more information.

FIXING

- WITH BATTENS (This is the recommended type of installation):

Wood, metal or PVC battens can be used. Place them perpendicular to the maximum pitch line, spacing each piece every 2 meters to allow the ventilation through the underside part of the tiles, ensuring a minimum air passing thru of 30 mm.

Keep in mind that in order to fix of the edges, the counter battens are prepared parallel with the maximum pitches line and perpendicular to the eave line.

To fix the ceramic pieces use nails or self drilling screws made of tempered and galvanized steel and washers for fixing them with a hammer or gun, or polyurethane foam or paste specially designed for fixing tiles. Finally, seal all holes*.

- WITH MORTAR:

Use the minimum quantity of mortar necessary to fix the ceramic pieces, and always do so in a way that allows the correct ventilation of all of the roofing pieces. We recommend the use of mortars (preferably waterproof) with a 1:2:10 ratio dosage; that is, for every m³ of dry sand, use 200 kg of hydraulic lime and 100 kg of cement.

* According to TEJAS BORJA's specifications

VENTILATION

The underside part of the tiles must be suitably ventilated to guarantee the adequate conservation of the covering, to prevent the formation of condensations and to prevent the ceramic pieces getting to the degree of saturation, issues that cause serious problems, especially in climatic zones with a high risk of frosts, throughout time.

Always provide an air entrance, an under tile air flow for the entire surface and an air exit on the highest part of the roof, usually to the ridgeline and hip line (on each face of the deck).

The air entrance is done on the eave line, without closing it off with mortar, using the plastic bird barrier or the TB-12® EAVE CLOSURE (12). The same goes for the valleys, if there are any.

The air flow over the entire roof it is obtained placing 1 TB-12® VENTILATION ROOF TILE for every 5 m², for a continuous deck (fixing with mortar) and 1 tile for every 10 m² for discontinuous deck (fixing with battens). Minimum 4 ventilation tiles are needed, two in the lower part of the roof and two in the upper part.

The air exit through the ridge line and hip line; be sure not to close these off with mortar, while placing RIDGES (28) (see page nº page 128 for accessories) and under ridges (31). Use VENTILATED ENCLOSURES FOR RIDGE LINE

To prevent the obstruction of air flow throughout the entire roof, use the minimum amount of mortar to fix the ceramic pieces (attaching with mortar), or interrupt the placement of the laths at two meter intervals (dry fixing) ensuring so the minimum air flow under tile of 30 mm.

See more information in page 176.

PITCH

Depending of the length of the deck and the geographical area or the place where it's situated (depending of wind, rain, altitude, nearness to the sea, etc.)

PITCH PANNEL (according to the roof length and geographical area)

	up to 6,5m.	from 6,5 to 9,5m.	from 9,5 to 12m.
Protected place	30%	33%	35%
Normal place	33%	36%	40%
Exposed place	40%	43%	50%

Para longitudes de faldón superior a 12 m., consultar.

LONG ROOF SURFACES

For roof lengths greater than 12 m, an intermediary gutter shall be used or waterproof the entire roof surface*.



MAINTENANCE

For a full conservation of the roof we recommend a regular inspection of it, removing moss, lichen, plants or any strange body that impedes the proper functioning of the roof.

TEJAS BORJAS' products are in agreement with the EU regulations, conforming to our certificates and documentation published in our catalogue and our website.

The method of roof tile placement is the responsibility of the installer. It should follow TEJAS BORJA's technical specifications.

TB-10



Installation details

See formats and finishing accessories in page 114

Universal circular edges and Universal circular straight end cap

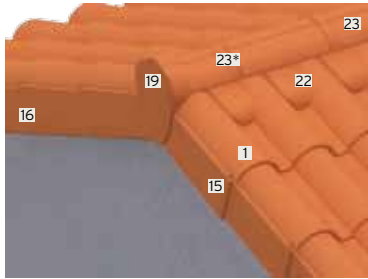

Eave line

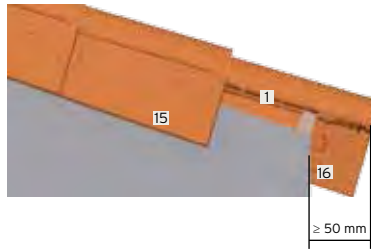

Ridge line

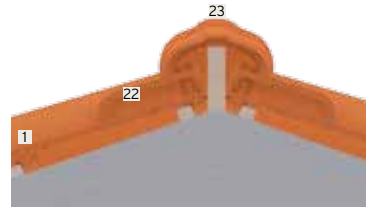

Monopitch

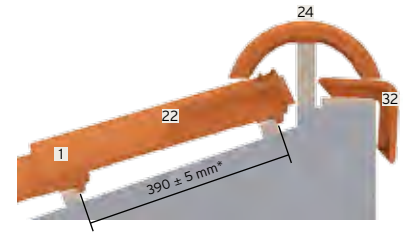

TB-10 curved edges and TB-10 circular curved end cap

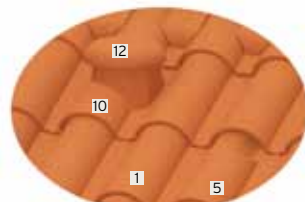
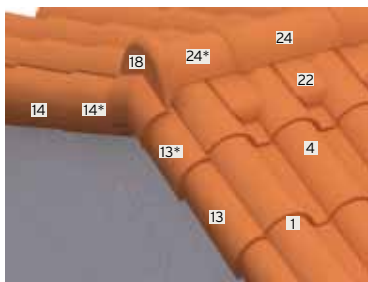

Ventilation cap option (Diagram B)

3-Ways



Hip line ventilation

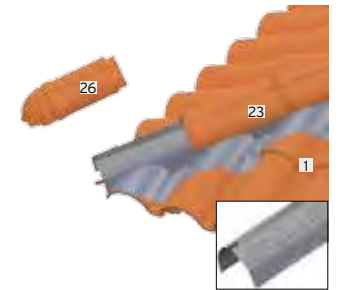

LH 517 section

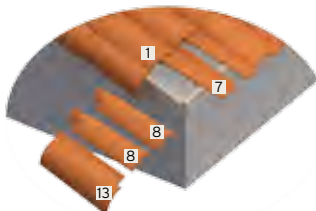

Decocurva® option (Diagram A)

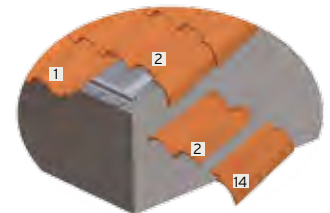
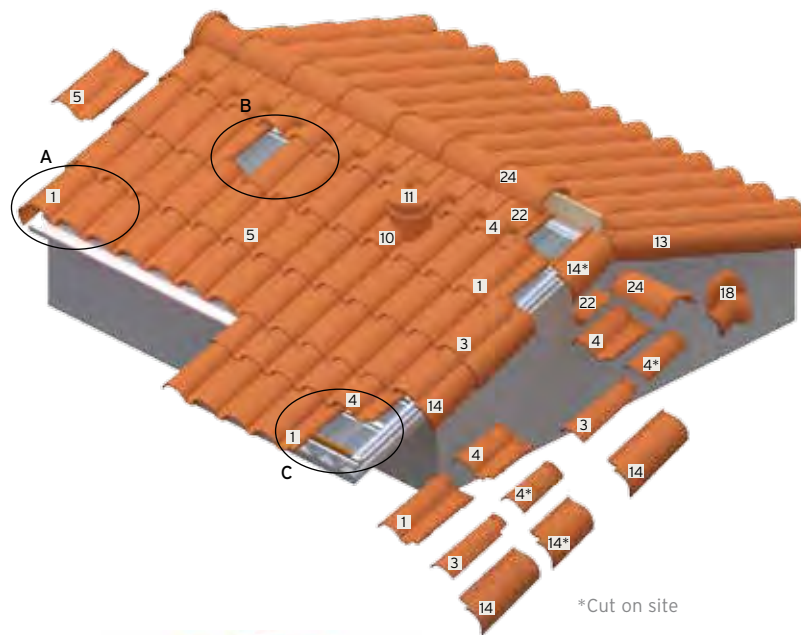

Tile and a half TB-10 option (Diagram D)

Eave line

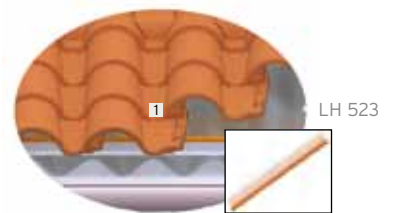
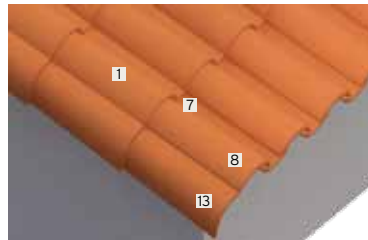

Plastic bird barrier (Diagram C)

Eave line with TB-10 Pan Decocurva® overhanging

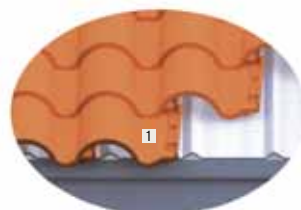

Underroofing sheet option. (adhesive or mortar fixing)

Eave line with TB-10 eave closure

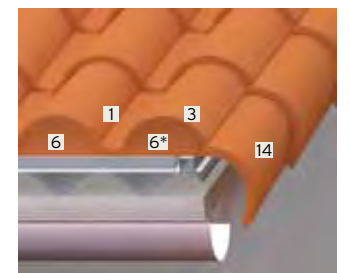
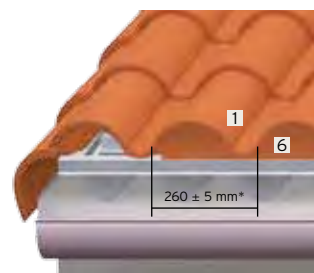

It is necessary to check the useful length on site, as per valid standards

Installation

See AutoCAD files on www.tejasborja.com

SUPPORT

This format can be placed on any type of structure, on mortar base or with wooden, metallic or PVC battens (RECOMMENDED) or continuous waterproof decking.

In any case, the deck surface has to be perfectly levelled. Special attention should be paid to sloping planes decks by smoothing down and levelling them with finishing mortar.

ROOF TILE INSTALLATION

Start placing the roof tiles at the left bottom corner of the deck. First the left edge (13 or 15) is placed and then all the tiles of the eave line; to guide the placing use a set square, and draw perpendiculars from the ridge line.

Then the tiles are placed from bottom to top and from left to right, checking that the roof tiles are correctly aligned. End in the right side with the RIGHT EDGE (14 or 16) and the HALF TB-10 ROOF TILE (3) or the TILE AND A HALF TB-10 (2).

The use of the HALF TB-10 ROOF TILE (3) or TILE AND A HALF TB-10 (2) enables us to avoid the need of the longitudinal cut of the roof tile. When the dimensions of the deck require it, the 2/3 TB-10 ROOF TILE (4) shall be used.

The TB-10 CURVED EDGES (13 and 14) and the UNIVERSAL STRAIGHT EDGES (15 and 16) protect the side wall plaster from dampness, providing the vertexes of the deck with an efficient protection, as well as giving a more aesthetic finishing.

The ridge line and hip line must be completed with ridges accessories (23-24; see page nº 128 for accessories) and UNIVERSAL UNDER RIDGE (22), in order to guarantee a better covering. At the end of the ridge line, TB-10 CURVED END CAP (18) or UNIVERSAL STRAIGHT END CAP (19) shall be placed and SENSE CHANGEMENT, 3 WAYS (27) or 4 WAYS pieces are used when needed. At the starting position of the hip line, the HIP STARTER (26) is placed. In case of monopitch the UNIVERSAL ANGULAR EDGE (32) shall be used placing it under the ridge.

When the eave line is solved with Decocurva® pieces (7 and 8), these have to be placed according to the specific installation details for TB-10 roof tile, or in general, according to the recommendations from Installation guide, page 174.

FIXING

- WITH BATTENS (This is the recommended type of installation.):

Wood, metal or PVC battens can be used. Place them perpendicular to the maximum pitch line, spacing each piece every 2 meters to allow the ventilation of the underside of the tiles, ensuring a minimum air passing thru of 30 mm.

Keep in mind that in order to fix of the edges, the counter battens are prepared parallel with the maximum pitches line and perpendicular to the eave line.

To fix the ceramic pieces use nails or self drilling screws made of tempered and galvanized steel and washers for fixing them with a hammer or gun, or polyurethane foam or paste specially designed to fix tiles. Finally, seal all holes*.

- WITH MORTAR:

Use the minimum quantity of mortar necessary to fix the ceramic pieces, and always do so in a way that allows the correct ventilation of all of the roofing pieces. We recommend the use of mortars (preferably waterproof) with a 1:2:10 ratio dosage; that is, for every m³ of dry sand, use 200 kg of hydraulic lime and 100 kg of cement.

VENTILATION

The underside part of the tiles must be suitably ventilated to guarantee the adequate conservation of the roof, to prevent the formation of condensations and to prevent the ceramic

pieces getting to the degree of saturation, issues that cause serious problems, especially in climatic zones with a high risk of frosts, throughout time.

Always provide an air entrance, an under tile air flow for the entire surface and an air exit on the highest part of the roof, usually to the ridge line and hip line (on each face of the deck).

The air entrance is done on the eave line, without closing it off with mortar, using the plastic bird barrier or the TB-10 EAVE CLOSURE (6). The same goes for the valleys, if there are any.

The air flow over the entire roof it's obtained placing 1 TB-10 VENTILATION ROOF TILE (5) for every 5 m², for a continuous deck (fixing with mortar) and 1 tile for every 10 m² for discontinuous deck (fixing with battens). Minimum 4 ventilation tiles are needed, two in the lower part of the roof and two in the upper part.

The air exit through the ridge line and hip line; be sure not to close these off with mortar, while placing RIDGES (23 or 24) (see page nº 128 for accessories) and UNDER RIDGES (22). Use VENTILATED ENCLOSURES FOR RIDGE LINE.

To prevent the obstruction of air flow throughout the entire roof, use the minimum amount of mortar to fix the ceramic pieces (attaching with mortar), or interrupt the placement of the battens at two meter intervals (dry fixing) ensuring so the minimum air flow under tile of 30 mm.

See more information in page 176.

PITCH

Depending of the length of the deck and the geographical area or the place where it's situated (depending of wind, rain, altitude, nearness to the sea, etc.)

PITCH PANNEL (according to the roof length and geographical area)

	up to 6,5m.	from 6,5 to 9,5m.	from 9,5 to 12m.
Protected place	30%	33%	35%
Normal place	33%	36%	40%
Exposed place	40%	43%	50%

Check with us for roofs longer than 12m.

LONG ROOF SURFACES

For roof lengths greater than 12 m, an intermediary gutter shall be used or waterproof the entire roof surface*.



MAINTENANCE

For a full conservation of the roof we recommend a regular inspection of it, removing moss, lichen, plants or any strange body that impedes the proper functioning of the roof.

TEJAS BORJAS' products are in agreement with the EU regulations, conforming to our certificates and documentation published in our catalogue and our website.

The method of roof tile placement is the responsibility of the installer. It should follow TEJAS BORJA's technical specifications.

* According to TEJAS BORJA's specifications

Alicantina Flat



Installation details

See formats and finishing accessories in page 116

End cap

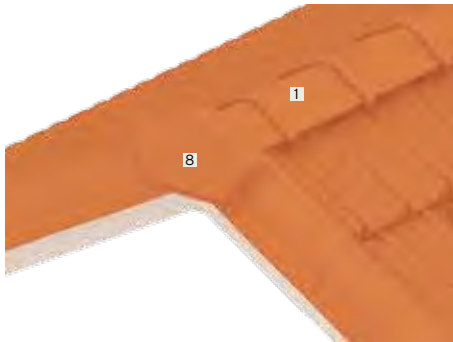

Ridge line

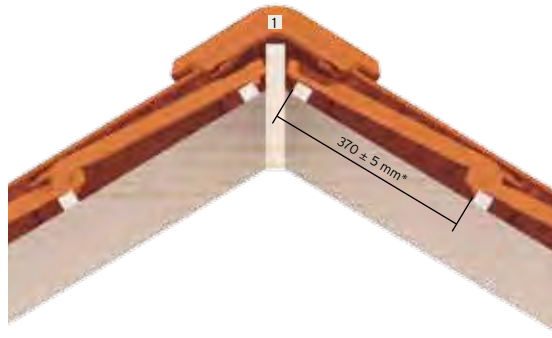

Monopitch

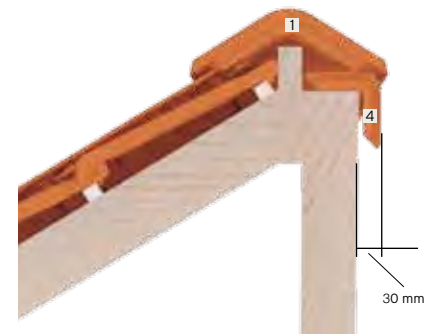

Ventilation

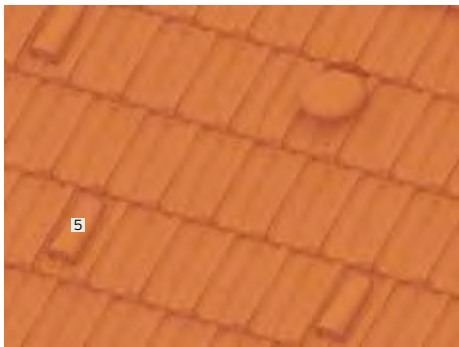

3 Ways

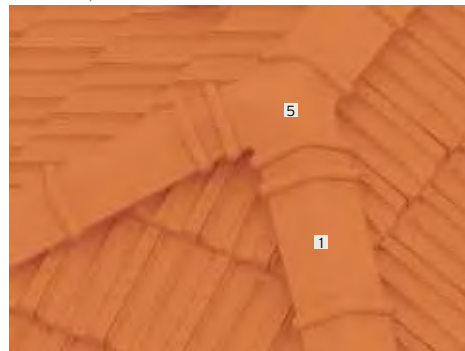

Hip line

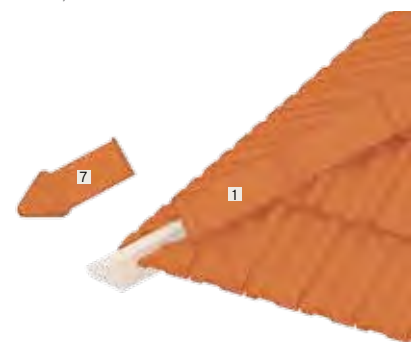

Eave line and edges accessories



* It is necessary to check the useful length on site, as per valid standards

Installation

See AutoCAD files on www.tejasborja.com

SUPPORT

This format can be placed on any type of structure, on mortar base or with wooden, metallic or PVC battens (RECOMMENDED) or continuous waterproof decking.

In any case, the deck surface has to be perfectly levelled. Special attention should be paid to sloping planes decks by smoothing down and levelling them with finishing mortar.

ROOF TILE INSTALLATION

Start placing the roof tiles at the right bottom corner of the deck. First all the tiles of the eave line are placed; to guide the placing use a set square, and draw perpendiculars from the ridge line.

Keep in mind that this format of roof tile is recommended to be installed in discontinuous joints or joined in "herringbone" fashion (in stepped course way) so that the LEFT HALF ALICANTINA FLAT ROOF TILE (2) and RIGHT HALF ALICANTINA FLAT ROOF TILE (3) shall be placed on the right and left sides of the roof surface. Using those pieces enables us to avoid the need of the longitudinal cut of the roof tile.

Then the UNIVERSAL STRAIGHT EDGE (4) pieces are placed, on the right and left side of the roof. Using those pieces the side wall plaster shall be protected from dampness, providing the vertexes of the deck with an efficient protection, as well as giving more aesthetic finishing.

In order to ensure a correct covering, the ridge line and hip line must be completed with the ANGULAR RIDGE (1). When needed, the ANGULAR 3 WAYS (6) and the FLAT / STRAIGHT END CAP (8) shall be used. At the starting position of the hip line, use the ANGULAR HIP STARTER.

FIXING

- WITH BATTENS (This is the recommended type of installation):

Wood, metal or PVC battens can be used. Place them perpendicular to the maximum pitch line, spacing each piece every 2 meters to allow the ventilation through the underside part of the tiles, ensuring a minimum air passing thru of 30 mm.

Keep in mind that in order to fix of the edges, the counter battens are prepared parallel with the maximum pitches line and perpendicular to the eave line.

To fix the ceramic pieces use nails or self drilling screws made of tempered and galvanized steel and washers for fixing them with a hammer or gun, or polyurethane foam or paste specially designed to fix tiles. Finally, seal all holes*.

- WITH MORTAR:

Use the minimum quantity of mortar necessary to fix the ceramic pieces, and always do so in a way that allows the correct ventilation of all of the roofing pieces*. We recommend the use of mortars (preferably waterproof) with a 1:2:10 ratio dosage; that is, for every m³ of dry sand, use 200 kg of hydraulic lime and 100 kg of cement.

VENTILATION

The underside part of the tiles must be suitably ventilated to guarantee the adequate conservation of the roof, to prevent the formation of condensations and to prevent the ceramic pieces getting to the degree of saturation, issues that cause serious problems, especially in climatic zones with a high risk of frosts, throughout time.

Always provide an air entrance, an under tile air flow for the entire surface and an air exit on the highest part of the roof, usually to the ridgeline and hip line (on each face of the deck).

The air entrance is done on the eave line, without closing it off with mortar. The same goes for the valleys, if there are any.

The air flow over the entire roof it is obtained placing 1 ALICANTINA FLAT VENTILATION ROOF TILE (5) for every 5 m², for a continuous deck (fixing with mortar) and 1 tile for every 10 m² for discontinuous deck (fixing with battens). Minimum 4 ventilation tiles are needed, two in the lower part of the roof and two in the upper part.

The air exit through the ridge line and hip line; be sure not to close these off with mortar, while placing RIDGES (1) (and accessories). Use VENTILATED ENCLOSURES FOR RIDGE LINE.

To prevent the obstruction of air flow throughout the entire roof, use the minimum amount of mortar to fix the ceramic pieces (attaching with mortar), or interrupt the placement of the laths at two meter intervals (dry fixing) ensuring so the minimum air flow under tile of 30 mm.

See more information in page 176.

PITCH

Depending of the length of the deck and the geographical area or the place where it's situated (depending of wind, rain, altitude, nearness to the sea, etc.)

	PITCH PANNEL (according to the roof length and geographical area)		
	up to 6,5m.	from 6,5 to 9,5m.	from 9,5 to 12m.
Protected place	40%	45%	50%
Normal place	42%	50%	60%
Exposed place	60%	70%	80%

LONG ROOF SURFACES

For roof lengths greater than 12 m, an intermediary gutter shall be used or waterproof the entire roof surface*.



MAINTENANCE

For a full conservation of the roof we recommend a regular inspection of it, removing moss, lichen, plants or any strange body that impedes the proper functioning of the roof.

TEJAS BORJAS' products are in agreement with the EU regulations, conforming to our certificates and documentation published in our catalogue and our website.

The method of roof tile placement is the responsibility of the installer. It should follow TEJAS BORJA's technical specifications.

* According to TEJAS BORJA's specifications



Curved roof tiles

40 x 19 / 40 x 15 / 45 x 20 / Celler® 50 x 21 / 25 x 12

Installation details

See formats and finishing accessories in page 118-122

RIDGE LINE

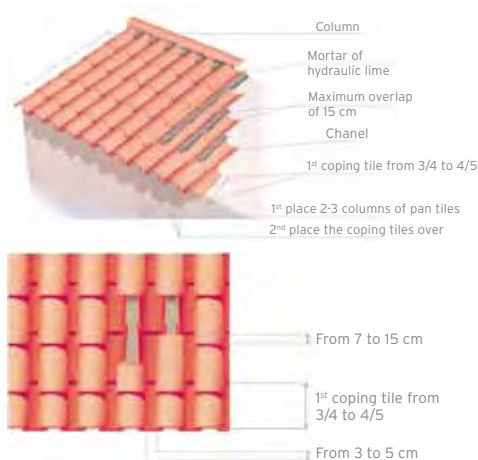

FINISHING ACCESSORIES

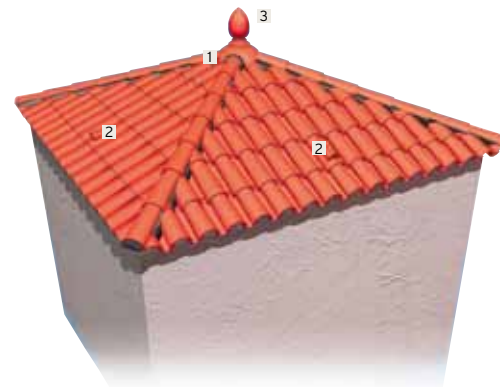
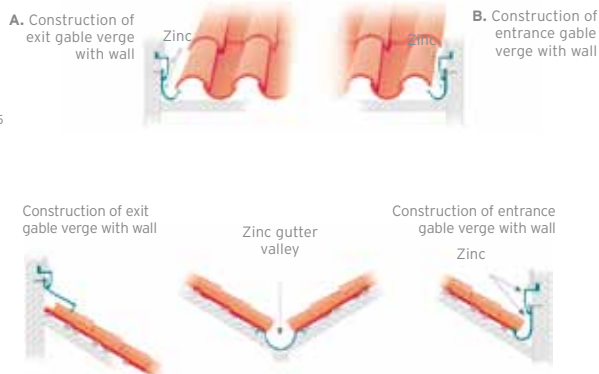

Installation

SUPPORT

This format can be placed on any type of structure. In any case, the roof surface should be levelled. Special attention should be paid to sloping planes decks by smoothing down and levelling them with finishing mortar.

ROOF TILE INSTALLATION

Start placing the roof tiles as a water evacuation channel, with the narrow entrance facing the lower part of the deck until three full columns of CURVED ROOF TILE shall be completed. Then three full columns of CURVED ROOF TILE are placed as cover, and then place one more as pan and so on. It is important to keep in mind the European current regulations while carrying out the placing works.

FIXING

- WITH MORTAR:

Use the minimum amount of mortar necessary to fix the ceramic pieces, and always do so in a way that allows for the correct ventilation of all of the roofing pieces*. We recommend the use of mortars (preferably waterproof) with a 1:2:10 ratio dosage; that is, for every m³ of dry sand, use 200 kg of hydraulic lime and 100 kg of cement.

DRY FIXING

For dry fixing, it's necessary the use of special clips for each format of curved roof tile. Also it is possible to place them with battens (see page 169)



VENTILATION

Clips for curved roof tile (galvanized steel)

The underside part of the tiles must be suitably ventilated to guarantee the adequate conservation of the roof, to prevent the formation of condensations and to prevent the ceramic pieces getting to the degree of saturation, issues that cause serious problems, especially in climatic zones with a high risk of frosts, throughout time.

Always provide an air entrance, an under tile air flow for the entire surface and an air exit on the highest part of the roof, usually to the ridge line or hip line and on each face of the deck.

The air entrance is done on the eave line, without closing it with mortar, using the plastic bird barrier or the EAVE CLOSURE (CELLER 50 X 21 and TC 40 X 15). The same goes for the valleys, if there are any.

The air flow over the entire roof it's obtained placing 1 VENTILATION ROOF TILE (TC 40X19, TC 40X15, TC 45X20 or CELLER® 50 X 21) for every 5 m², for a continuous deck (fixing with mortar) and 1 tile for every 10 m² for discontinuous deck (fixing with battens). Minimum 4 ventilation tiles are needed, two in the lower part of the roof and two in the upper part.

The air exit through the ridge line and hip line; be sure not to close these off with mortar. Use VENTILATED ENCLOSURES FOR RIDGE LINE.

The 25x12 CURVED ROOF TILE it's a decorative format and has no ventilation tile.

To provide an air flow for the entire deck the minimal quantity of mortar shall be used to fix of the ceramic pieces.

See more information in page 176.

See AutoCAD files on www.tejasborja.com

VERTICAL OVERLAP & PITCH

According to regulation guide NTE-QTE (1974 from M.O.P.T.), the minimum vertical S overlap in mm for curved roof tiles shall be determined by the area of winds, storms, and topographical altitude, taking in consideration the pitch of the roof

Pitch (°)	15	16	17	18	19	20	21	22	23	24	>25
Pitch (%)	26	28	30	32	34	36	38	40	42	44	>46
Protected place	150	140	135	130	125	120	115	110	100	100	70
Normal place	150	145	140	135	130	125	120	110	100	70	
Exposed place	150	145	140	135	130	120	100	70			

*minimum vertical S overlap in mm.

LONG ROOF SURFACES

For roof lengths greater than 12 m, an intermediary gutter shall be used or waterproof the entire roof surface*.

MAINTENANCE

For a full conservation of the roof we recommend a regular inspection of it, removing moss, lichen, plants or any strange body that impedes the proper functioning of the roof.

TEJAS BORJAS' products are in agreement with the EU regulations, conforming to our certificates and documentation published in our catalogue and our website.

The method of roof tile placement is the responsibility of the installer. It should follow TEJAS BORJA's technical specifications.

* According to TEJAS BORJA's specifications

Installation details

See formats and finishing accessories in page 131

REMATES:

Figure A



Ridges

Ridges on course of rounded Kastor roof tile with ridge piece nailed on for ridges on ridge beam. Ventilation occurs through the vent pieces on the ridge and also through our LH 517 section.

Figure B



Edges

The all-purpose edges have an overlap of width of covering of: approx. 9.0 cm. and 3 pieces/linear meter.

Figure C



Eaves

Eave with double strip
Wood shuttering, bituminous waterproof layer, counter-shuttering and comb in PVC to restrict the access of birds.

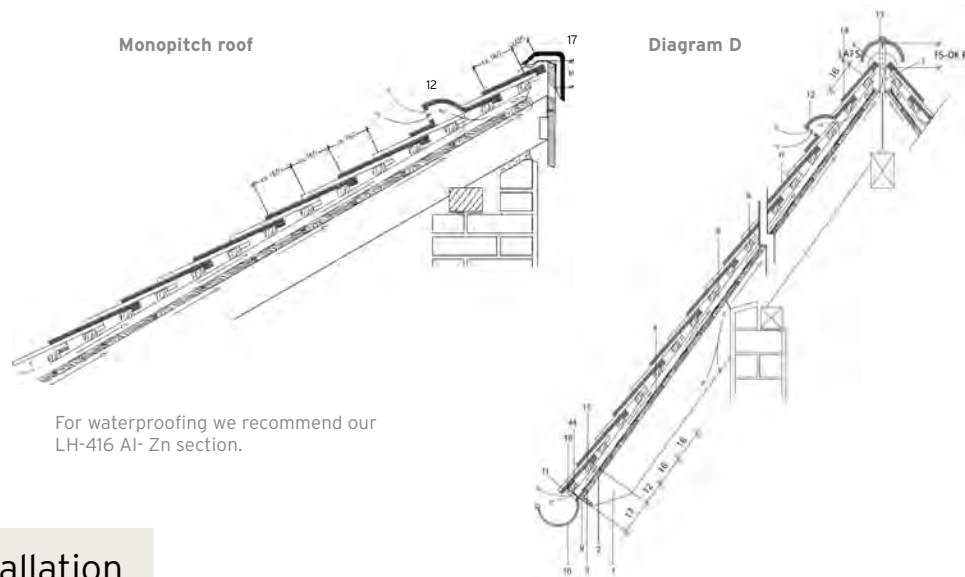

For waterproofing we recommend our LH-416 Al- Zn section.

Installation

MONOPITCH ROOF

A monopitch roof with a lower structure and rafters that reach to the outer face of the masonry work, with a ridge and aluminium clip for ridge tiles. Roof ventilation by means of a system of vent tiles with a skylight in the second course below the ridge of the roof. In an alternating manner: laying of the dry lead angle rafter (LH-416 Al-Zn) with no ceramic system of ventilation.

In an alternating manner: ventilation of the ridge.

Pitch (%)	LAPS	H	
60	6,0 cm.	6,0 cm.	
70	5,5 cm.	6,0 cm.	
85	5,0 cm.	6,0 cm.	
100	4,5 cm.	6,5 cm.	
120	4,0 cm.	6,5 cm.	
145	3,5 cm.	7,0 cm.	LAPS. Overlap
175	3,0 cm.	7,0 cm.	H. Monopitch ridge

GENERAL CONSIDERATIONS

In the roof, only one course of KASTOR ROOF TILES rests on each batten as a structure for covering the roof. With the course situated below and the course situated above, it forms a perfectly interconnecting structure, separating each one of the courses with a break joint. The courses overlap in such a way that the third still partially covers the first course. The courses on the eave and on the ridge each count as a base layer and another of covering formed by UNDER EAVE KASTOR and UNDER RIDGE roof tiles (see Figures A and C). Alternatively, a crowning layer of KASTOR ROOF TILES may also be laid instead of the eave and ridge roof tiles (see Figure B). The lower batten on the roof is nailed in a vertical position and sawn flush with the lower edge of the rafter or is fitted in duplicate or is erected by placing a piece as an under ridge. The second batten is nailed down at a distance of approx. 17 cm., measured from the lower edge of the first batten to the upper edge of the second batten, using UNDER EAVE KASTORROOF TILES. The UNDER EAVE KASTORROOF TILES or starter roof tiles are fixed onto this second batten. The third batten is placed at a distance of around 12 cm., measured from the upper edge of the second batten to the upper edge of the third batten. Finally, a structure of battens is laid at a distance of some 16 cm. in the case, for example, of a roof with a pitch of approx. 100% -145%.

The distance between the upper batten and the crown of the ridge beam should be around 7.0 - 9.5 cm.

The UNDER RIDGE ROOF TILES are fixed onto the last course of KASTOR ROOF TILES. This means that the separation regarding the crown of the ridge beam is only 5 - 6 cm.

DIARGAM D:

Section of roof with projection, double-flanged roof with Kastor roof tiles of approx. 8 x 38 x 1.5 cm Eave with a piece in the shape of an under ridge and closed boarding or shuttering. The distances between battens in the roof according to the pitch are as follows:

≥ 60%	14,5 cm.	≥ 85%	15,5 cm.	≥ 120%	16 cm.	≥ 175%	16,5 cm.
≥ 70%	15,0 cm.	≥ 100%	16,0 cm.	≥ 145%	16 cm.		

* Waterproofing is recommended on pitches superior to 100%.

** According to TEJAS BORJA 's specifications

0.- Kastor roof tile

1.- Rafters

2.- Wood boarding or shuttering

3.- Pieza en forma de cuña

4.- Sealed roll roofing

5.- Lath

6.- Batten

7.- Ridge beam

8.- Diagonal hip baulk

9.- Projection

10.- Gutter hook on eave

11.- Eave plate (Flashing)

12.- Kastor Ventilation roof tile

13.- Kastor Ridge

14.- Under Ridge Kastor roof tile

15.- Under Eave Kastor roof tile

16.- Plastic bird barrier

17.- Monopitch Kastor ridge

Table of overlaps in terms of the pitch of the finishing tiles

Pitch in %	Ventilation roof tiles					
	Ridge		Ridge		Ridge tiles	
	LAFS*	FS-OK FB**	LAFS*	FS-OK FB**	LAFS*	FS-OK FB**
60	9,0 cm.	6,5 cm.	8,5 cm.	5,0 cm.	4,5 cm.	8,0 cm.
70	8,5 cm.	6,5 cm.	8,5 cm.	4,5 cm.	4,0 cm.	8,0 cm.
85	8,0 cm.	6,0 cm.	8,0 cm.	4,5 cm.	3,5 cm.	7,5 cm.
100	7,5 cm.	6,0 cm.	8,0 cm.	4,0 cm.	3,0 cm.	7,5 cm.
120	7,0 cm.	5,5 cm.	8,0 cm.	3,5 cm.	2,5 cm.	7,5 cm.
145	7,0 cm.	5,5 cm.	7,5 cm.	3,5 cm.	2,0 cm.	7,5 cm.
175	7,0 cm.	5,0 cm.	7,5 cm.	3,5 cm.	1,0 cm.	7,5 cm.

Ridge LAFS*. Distance from the upper edge O1 the batten to the crown O1 the ridge.

FS-OK FS**. Distance from the crown of the ridge to the upper edge of the ridge beam.

VENTILATION

The underside part of the tiles must be suitably ventilated to guarantee the adequate conservation of the roof, to prevent the formation of condensations.

The air entrance is done on the eave line, without closing it off with mortar. The same goes for the valleys, if there are any.

Place 1 KASTOR VENTILATION ROOF TILE (12) for every 10 m², for discontinuous deck (fixing with battens). Minimum 4 ventilation tiles are needed, two in the lower part of the roof and two in the upper part.

The air exit through the ridge line and hip line; be sure not to close these off with mortar. Use VENTILATED ENCLOSURES FOR RIDGE LINE

To prevent the obstruction of air flow throughout the entire roof, use the minimum amount of mortar to fix the ceramic pieces (attaching with mortar), or interrupt the placement of the battens at two meter intervals (dry fixing) ensuring so the minimum air flow under tile of 30 mm. See more information in page 176.

LONG ROOF SURFACES

For roof lengths greater than 8 m, an intermediary gutter shall be used or waterproof the entire roof surface**.

MAINTENANCE

For a full conservation of the roof we recommend a regular inspection of it, removing moss, lichen, plants or any strange body that impedes the proper functioning of the roof.

Installation details

See formats and finishing accessories in page 124

OVERLAPPING SYSTEM

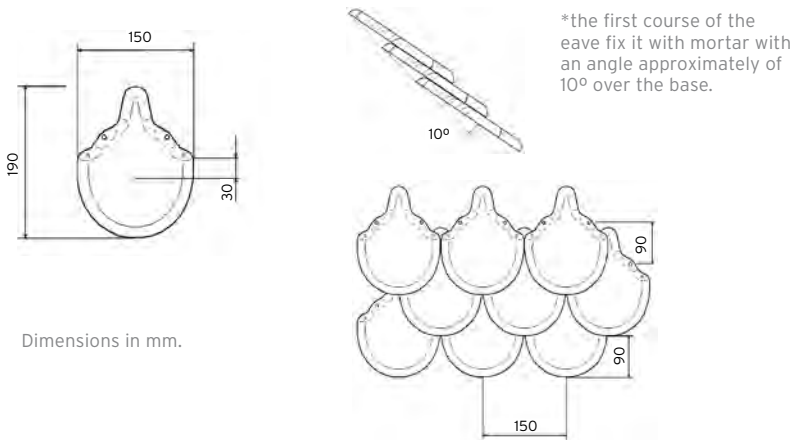

Dimensions in mm.

DRY FIXING WITH BATTENS

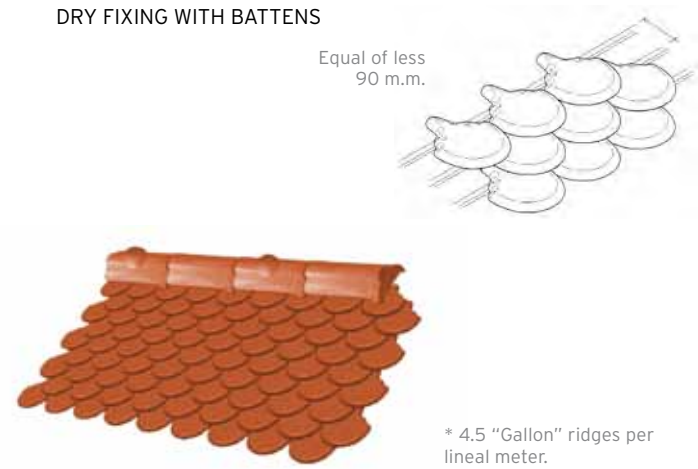

* 4.5 "Gallon" ridges per lineal meter.

Installation

GENERAL INFORMATION

ESCAMA ROOF TILE is a roof tile format that has almost disappeared from the market nowadays and which TEJAS BORJA has brought back with a wide range of designs and finishes; it is placed on site using the former installation system.

ESCAMA roof tile is placed in courses parallel to the eaves of the roof and the first of them is then filled in appropriately, doing the same with the rest, checking at all times that the Escama roof tiles are properly aligned.

The tiles have to be cut in the ridge and hip lines, as defined by their alignment, and the "Gallon" ridge is then put into position to ensure a better covering.

FIXING

Fixing system recommendations.

DRY FIXING

With traditional mortar filling in the entire surface area of the tile on its engraved underside so that the material adheres more easily, removing any surplus and joining all the tiles.

In the cases of extreme pitches, the fixing to the support is improved with galvanised nails that are put through the perforations of the tiles when the mortar is still soft to reinforce the fixing*.

In cases of dry installation (with battens), fixing is done with self tapping galvanised tempered steel nails or screws.

We recommend suitable sealing of the holes with mastic after fixing has been put though them*.

PITCHES

As the Escama roof tile has a flat section without fittings, the use of waterproofing is recommended in all the cases described above and for any pitch.

MAINTENANCE

For proper conservation of an Escama roofing, moss, lichens, plant matter or any other strange bodies should be removed.

TEJAS BORJAS' products are in agreement with the EU regulations, conforming to our certificates and documentation published in our catalogue and our website.

The method of roof tile placement is the responsibility of the installer. It should follow TEJAS BORJA's technical specifications.

* According to TEJAS BORJA's specifications



Escama Royal

Installation details

See formats and finishing accessories in page 125

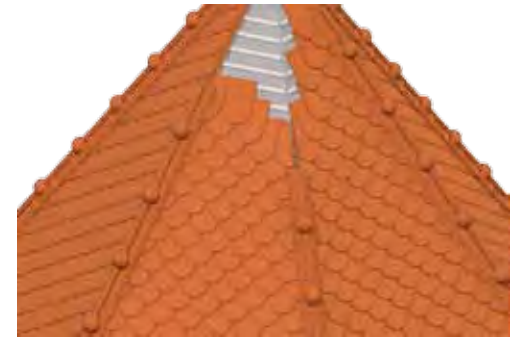
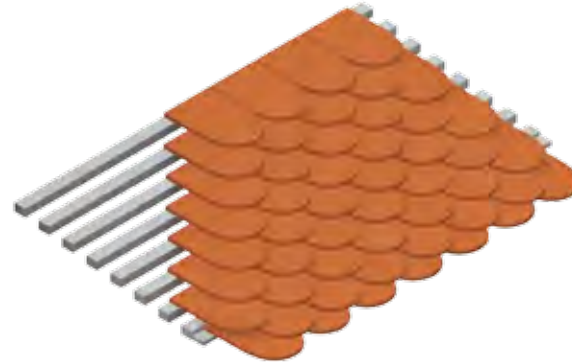
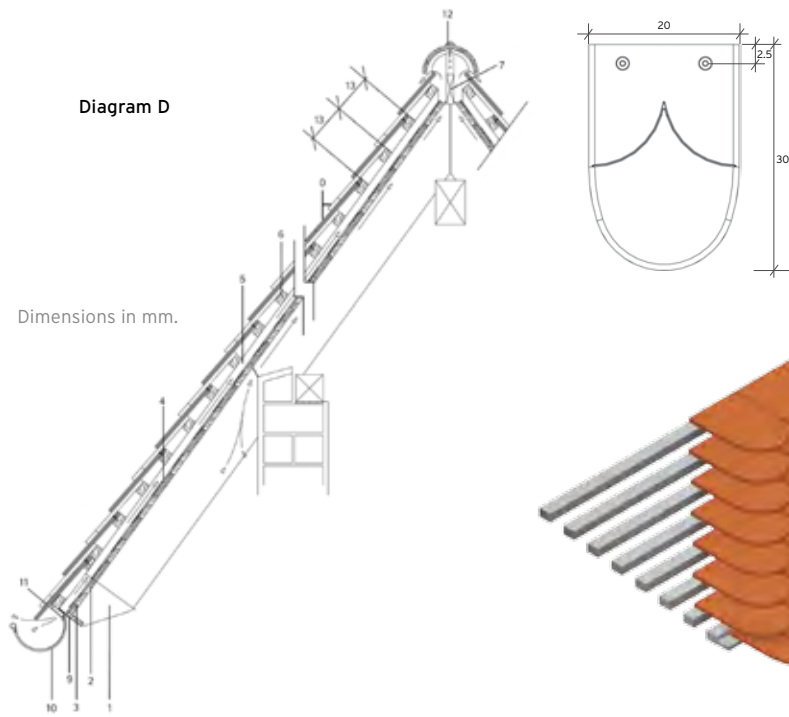

* 4.5 "Gallon" ridges per lineal meter.

Installation

GENERALIDADES

In the roof, only one course of ESCAMA ROYAL ROOF TILES rests on each batten as a structure for covering the roof. With the course situated below and the course situated above, it forms a perfectly interconnecting structure, separating each one of the courses with a break joint. The courses overlap in such a way that the third still partially covers the first course. The inferior batten is nailed in vertical position, cut at inferior rafter level or is placed double joining the second layer with the first course of tiles. The second batten is nailed to a distance of approximately 1 cm between the upper edge of the first course of tiles and the lower edge of the second batten. For pitches between 100% - 145%, the battens shall be placed at a distance of 10,5 - 12 cm, for example for a monopitch roof.

DIARGAM D:

Section of roof with projection, double-flanged roof with ESCAMA ROYAL roof tiles of approx. 20x30x1,5 cm. Eave with a piece in the shape of an under ridge and closed boarding or shuttering. The distances between battens in the roof according to the pitch are as follows:

≥ 60%	9 cm.	≥ 120%	11 cm.
≥ 70%	9,5 cm.	≥ 145%	12 cm.
≥ 85%	10 cm.	≥ 175%	13 cm.
≥ 100%	10,5 cm.		

*Waterproofing is recommended on pitches of more than 100% .

- 0.- ESCAMA ROYAL roof tile
- 1.- Rafters
- 2.- Wood boarding or shuttering
- 3.- Shaped piece
- 4.- Sealed roll roofing
- 5.- Lath
- 6.- Batten
- 7.- Ridge beam
- 8.- Diagonal hip baulk
- 9.- Projection
- 10.- Gutter hook on eave
- 11.- Eave plate (Flashing)
- 12.- Ridge

* According to TEJAS BORJA´ s specifications

The ESCAMA ROYAL roof tile is placed in courses parallel to the eaves of the roof and the first of them is then filled in appropriately, doing the same with the rest, checking at all times that the Escama roof tiles are properly aligned.

The tiles have to be cut in the ridge and hip lines, as defined by their alignment, and the "Gallon" ridge is then put into position to ensure a better covering

FIXING

Fixing system recommendations (always dry fixing).

DRY FIXING

In cases of dry installation (with battens), fixing is done with self tapping galvanised tempered steel nails or screws.

We recommend suitable sealing of the holes with mastic after fixing has been put though them*.

The same traditional installation can be done with mortar as for Escama roof tile, but for this format having a flat section, we recommend its installation by dry fixing.

PITCHES

The base support should have the minimum planimetry for its possible deviation shall not intervene in the flatness of the tiles and their installation. If the installation is not done with battens, the surface has to be flat in all cases.

As the Escama Royal roof tile has a flat section without fittings, the use of waterproofing is recommended in all the cases described above and for any pitch lower than 100%.

MAINTENANCE

For proper conservation of an Escama Royal roofing, moss, lichens, plant matter or any other strange bodies should be removed.

TEJAS BORJAS´ products are in agreement with the EU regulations, conforming to our certificates and documentation published in our catalogue and our website.

The method of roof tile placement is the responsibility of the installer. It should follow TEJAS BORJA´ s technical specifications.

INSTALLATION GUIDE

- 160 Roof surface: types and elements
- 162 Ceramic roof tiles characteristics
- 164 Specifications for ceramic roof tiles installation
- 167 Batten layout
- 170 Fixing materials
- 171 Mortars for fixing of singular points
- 172 Eave installation Decocurvas®
- 176 Ventilation
- 178 Ridge line and hip line installation
- 182 Edges installation
- 183 Bibs and gutters installation
- 185 Cornices installation
- 188 Warnings
- 188 Safety conditions on site
- 189 Difference from tonality and superficial aspects of the tiles (Standard regulation EN 1304)
- 191 Roof maintenance

Roof surface: types and elements

ROOF SURFACE: TYPES AND ELEMENTS

When a roof is designed, all details should be taken into consideration to protect the house against external elements, paying special attention to the convenient evacuation of rainwater and the wind effects, as well as the minimum pitch recommended per climatic zones and ven-

tilation and fixing standards according to UNE 136020 for ceramic roof tiles installation.

There are many different covering' types, although the majority are combinations of the first four:

TYPES OF ROOFS

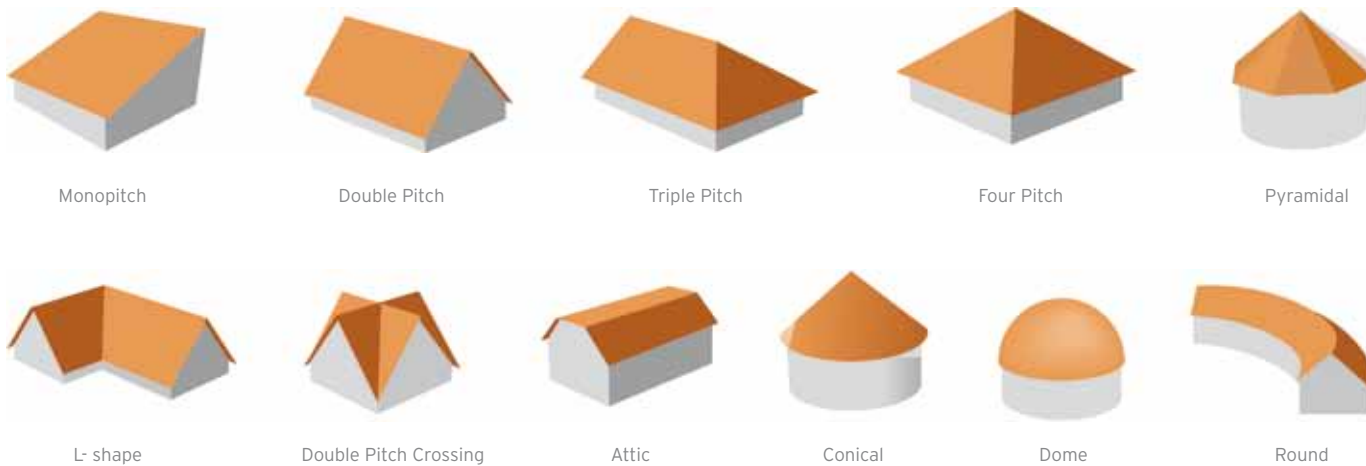

TYPES OF ATTIC



ELEMENTS OF A ROOF SURFACE

The name and position of the parts of any kind of roof are shown in the following diagram:

- 1. Hip line
- 2. Valley
- 3. Ridge line
- 4. Monopitch
- 5. 3-Ways ridge
- 6. Eave
- 7. Roof deck
- 8. Right edge
- 9. Left edge
- 10. Cantilever roof
- 11. Ornamental detail
- 12. Mansard roof
- 13. Attic
- 14. Skylight
- 15. Windows' roof
- 16. Chimney

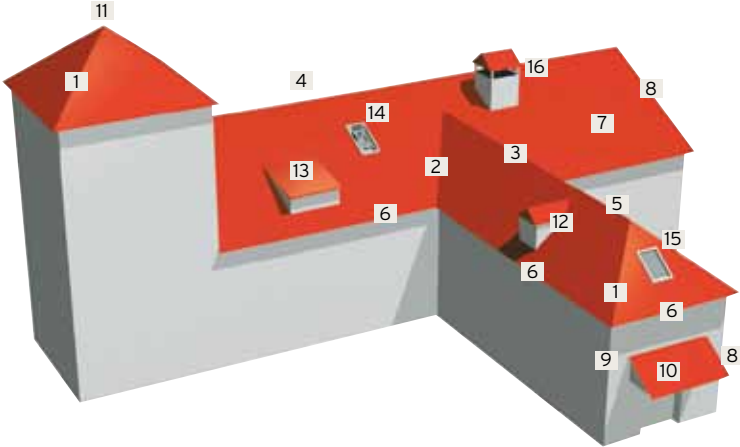

Ceramic roof tiles characteristics

The ceramic roof tiles must have a set of characteristics regarding mechanical resistance to flexion, durability, impermeability and thermal isolation. Also it is necessary that they are of easy placement on site.

RESISTANCE

The mechanical resistance of the tiles performs vital importance, since they can be walked on for execution of eventual works of repair or maintenance. For this reason, Tejas Borja presents the highest values of resistance to flexion.

DURABILITY

The durability of the tiles represents a great importance, since they are going to be exposed directly in the open air without any type of protection. Take into consideration that rain water and dampness saturation of the air can generate dissolved salts attacking chemically the product and can cause, slowly, the degradation; keep this factor in mind especially in zones near the sea.

The durability of the tiles can also be affected by the action of the ice, so since it is known, the freezing process increases the volume around 9 %. This expansion, in unfavourable conditions of ventilation, can cause damages in its structure. In those cases of remarkable decrease of temperatures, with negative values, impedes the water to evaporate from the pores of the tile, the tile will be subject to internal tension that can cause breaks in of shape of stone chips (known like "chipping").

See more information in page 176.

The temperature of firing of our ceramic pieces guarantees the good response to the frosts, in agreement with the standard regulation.

WATEPROOFING

To avoid dampness and possible leakage through the ceramic tiles it is necessary to take into account that the underside face of the tiles must be suitably ventilated, so condensations are avoided allowing it to dry up.

The tiles must be placed on roof deck with enough slope to allow offsetting the combined action of the wind and the rain, depending (this slope) of the altitude where the construction is located, of the fulfilment of slopes and of the wind exhibition of the roof; in any case it will never have to be lower than 30 %.

THERMAL ISOLATION

Since the thermal isolation is important, either from the point of view of living comfort as well as of energetic saving, it turns out to be relevant the response of the materials chosen for the roof. Therefore, the tests done in specialized institutions confer to the ceramic tile the best results compared with other types of materials used in roofs, with the same purpose.

IMPORTANT

In order to achieve a good response of our ceramic tiles on site and to be able to fulfil the fundamental characteristics described previously, it is essential that the installation is executed as indicated on our **“Specifications for ceramic roof tiles installation”**. It is convenient that certain works, must follow always the good practices of construction for the placement of this material and to the standard regulation UNE-136020 of design and installation of roofs with ceramic tiles. In case of doubt check with our **“technical services”**



Specifications for ceramic roof tiles installation

PITCHES OF THE ROOF DECKS

The slopes of the decks are very important for the good result of the tiles regarding the evacuation of the rain water. On the other hand, a major slope facilitates the air

flow necessary for a faster drying of the roof tiles in the periods rain. See minimum pitch values in the panel on the next page.

CLIMATIC ZONES (standard regulation UNE-136020)

Weather conditions based on geographical situation may be considered. In general, there are three types of zones classified as follows:

Protected place: Valley surrounded by hills that can protect it from strong or very strong winds

Normal place: Flat ground or plateau with less important uneven areas

Exposed place: High wind areas, areas up to 5 Km from the coast, islands or narrow peninsulas, estuaries or narrow bays, narrow valleys, mountain isolated and ports of mountain.

For locations with permanent wind exposure as per the average values, not showed in our scale, it must use also the

average values of the percentages indicated for its particular Climatic Zones.

PITCH DIAGRAM ACORDING TO ROOF LENGTH AND GEOGRAFIC AREA (Norma UNE 136020)

TB-4 Quattro® TB-12® TB-10

	UP TO 6.5 M	FROM 6.5 TO 9.5 M	FROM 6.5 TO 9.5 M
PROTECTED PLACE	30%	33%	35%
NORMAL PLACE	33%	36%	40%
EXPOSED PLACE	40%	43%	50%

Consult for roofs longer than 12 m.

ALICANTINA FLAT

	UP TO 6.5 M	FROM 6.5 TO 9.5 M	FROM 6.5 TO 9.5 M
PROTECTED PLACE	40%	45%	50%
NORMAL PLACE	42%	50%	60%
EXPOSED PLACE	60%	70%	80%

Consult for roofs longer than 12 m.

TB-FLAT (consult specifications in the catalogue)

CURVED ROOF TILES (vertical overlap according to pitch)

PITCH (°)	15	16	17	18	19	20	21	22	23	24	>25
PITCH %	26	28	30	32	34	36	38	40	42	44	>46
PROTECTED PLACE	150	140	135	130	125	120	115	110	100	100	70
NORMAL PLACE	-	150	145	140	135	130	125	120	110	100	70
EXPOSED PLACE	-	-	-	150	145	140	135	130	120	100	70

Minimum vertical overlap in mm.

KASTOR Distance between battens according to pitch

⊕ 60%	14,5cm
⊕ 70%	15,0 cm
⊕ 85%	15,5 cm
⊕ 100%	16 cm
⊕ 120%	16 cm
⊕ 145%	16 cm
⊕ 175%	16,5 cm

Waterproofing for any pitch < 100% is recommended.

ESCAMA & ESCAMA ROYAL

Total waterproofing for any pitch is needed.

CALCULATION OF THE LENGTH OF ROOF

If the length of the roof is not marked on the drawings, it should be calculated from its horizontal projection.

Slopes diagram and coefficients to determine the length of the roof Types of tiles used according to the slopes

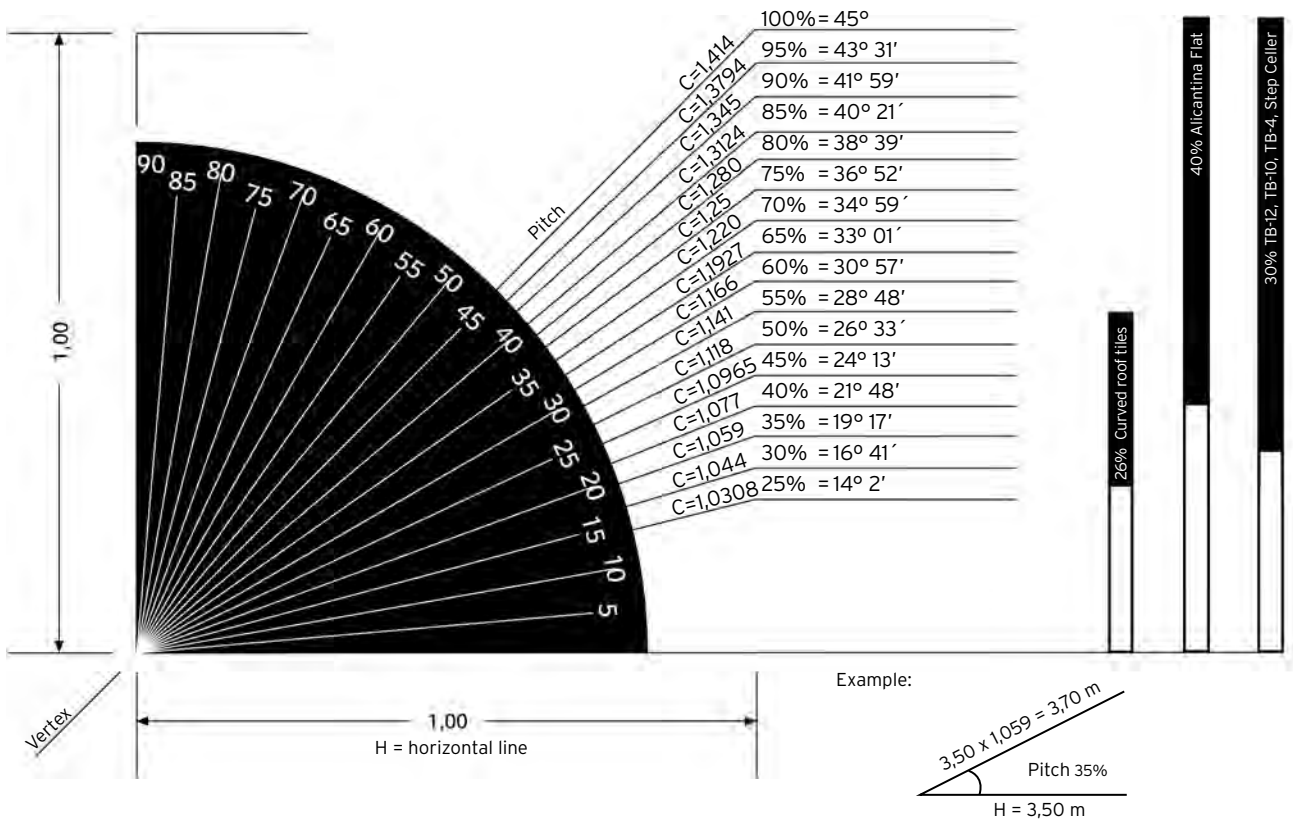

Coefficiente "K" (m/m)

Pitch %	19	20	21	22	23	24	25	26	27	28	29	30
Slope °	10°45	11°18	11°51	12°24	12°57	13°29	14°02	14°34	15°06	15°38	16°10	16°41
Coefficient "K"	1,0179	1,0198	1,0218	1,0239	1,0261	1,0284	1,0308	1,0332	1,0358	1,0384	1,0412	1,0440
Pitch %	31	32	33	34	35	36	37	38	39	40	41	42
Slope °	17°13	17°44	18°15	18°46	19°17	19°47	20°18	20°48	21°18	21°48	22°17	22°46
Coefficient "K"	1,0469	1,0499	1,0530	1,0562	1,0595	1,0628	1,0662	1,0697	1,0733	1,0770	1,0808	1,0846
Pitch %	43	44	45	46	47	48	49	50	51	52	53	54
Slope °	23°16	23°44	24°13	24°42	25°10	25°38	26°06	26°33	27°01	27°28	27°55	28°22
Coefficient "K"	1,0885	1,0925	1,0965	1,1007	1,1049	1,1092	1,1135	1,1180	1,1225	1,1271	1,1317	1,1365
Pitch %	55	56	57	58	59	60	61	62	63	64	65	70
Slope °	28°48	29°14	29°40	30°06	30°32	30°57	31°22	31°47	32°12	32°37	33°01	34°59
Coefficient "K"	1,1413	1,1461	1,1510	1,1560	1,1610	1,1661	1,1713	1,1766	1,1819	1,1872	1,1927	1,2206
Pitch %	75	80	85	90	95	100	105	110	115	120	125	130
Slope °	36°52	38°39	40°21	41°59	43°31	45°00	46°40	47°73	48°99	50°19	51°34	52°43
Coefficient "K"	1,2500	1,2806	1,3124	1,3453	1,3793	1,4142	1,4500	1,4866	1,5240	1,5620	1,6008	1,6401
Pitch %	135	140	145	150	155	160	165	170	175	180	185	190
Slope °	53°47	54°46	55°41	56°31	57°17	57°99	58°78	59°53	60°26	60°95	61°61	62°24
Coefficient "K"	1,6800	1,7205	1,7614	1,8028	1,8446	1,8868	1,9294	1,9723	2,0156	2,0591	2,1030	2,1471
Pitch %	195	200	205	210	215	220	225	230	235	240	245	250
Slope °	62°85	63°43	64°00	64°54	65°06	65°56	66°04	66°50	66°95	67°38	67°80	68°20
Coefficient "K"	2,1915	2,2361	2,2809	2,3259	2,3712	2,4166	2,4622	2,5080	2,5539	2,6000	2,6462	2,6926

Batten layout

There are different solutions for fixing the tiles, also different materials to be used. The type of structure is important, since it will affect the durability of the tiles. Its efficiency is directly related to the foreseen slope, in such a way that as minor is the slope, better ventilation will be needed through the underside face of the roof.

CALCULATING THE DISTANCE BETWEEN BATTENS (Standard regulation UNE-136020)

The distance between the battens should be determined from the roof tiles chosen, as follows:

a) Choose randomly 12 roof tiles from different pallets. On a plane surface, place the tiles, in a longitudinal row so the tiles will be as apart as possible. Measure the maximum length B (in cm) in between the 2nd and the 12th tile as shown in the following drawing:

b) Next, do the same with the tiles as close as possible and measure the distance b (in cm)

c) When the value of the first setting is small, the distance between battens (A) is given by formula:

$$A = (B + b) / 20$$

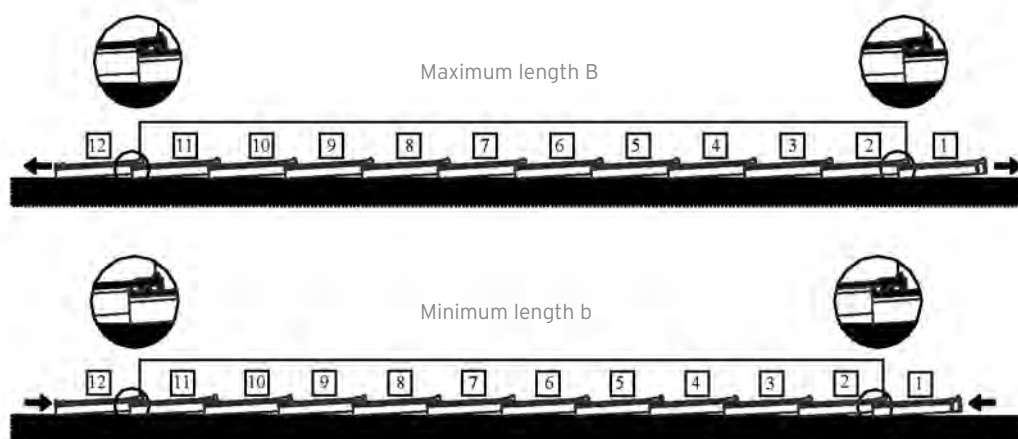

When the same value is large, the distance between battens is given by formula:

$$A = (b + 5) / 10$$

d) This distance should be marked rigorously over both edges of the pitch by using for it a measuring tape com-

pletely spread out and following the line of bigger slope, which means it should be perpendicular on the eave line. After this operation and with help of a marking wire extended between every two opposite points placed to the same level between both edges of the pitch, the whole roof is marked successively, having the battens placed as per the marked line, in each level.

FIXING AND BATTENS

For pitches between 70% and 100% or in exposed places, "all the roof tiles' eaves, ridges and edges must be screwed or nailed (Level "B", standard regulation UNE-136020:).

For pitches between 100% and 175%, the roof tiles must be nailed in a minimal proportion of at least 1 tile every 5 and in a regular way (Level "C", standard regulation UNE-136020:).

For pitches higher than 175%, all the roof tiles must be nailed (Level "D", standard regulation UNE-136020:).

For nailing the roof tiles, it will be necessary to drill through the hole pre-marked from the factory. **These holes will have to be sealed later on.**

Flat and interlocking roman roof tile fixing: Level "C"

FILES HORIZONTALES	FILES VERTICALES																				
	0	1	2	3	4	5	6	7	8	9	10	11	12	13	14	15	16	17	18	19	20
6																					
5																					
4																					
3																					
2																					
1																					
0																					

TYPES OF BATTENS

WOOD BATTENS

They will be of pine wood with a natural aging of 6 months, dampness lower than 8 % and treated against mould and insects. It will present neither warping nor knots. The habitual sections for the strips are indicated in the following table, being able to justify with calculation different sections and distances between the axes.

The standard regulation UNE-136020:2004 specifies rectangular section of the battens should be 35 x 45 mm with +/- 5 mm of tolerance.

In the above mentioned standard regulation also it is indicated how wood battens are fixed on concrete roof support, with nails or mortar.

METAL BATTENS

Should be galvanized and normally omega hollowed profile. It should have the minimum resistance to guarantee the roof stability.

MORTAR BATTENS

They will be done on site with M-40 mortar (cement mortar).

Section dimensions	Maximum distance between support axes in meters according to the load in Kg. / m ²		
	100	150	200
height x width			
18 x 25	400	350	300
22 x 25	450	430	400
25 x 25	550	500	450
25 x 32	600	540	500
25 x 38	640	570	520
25 x 50	700	600	550
32 x 32	790	700	650
32 x 38	830	740	680
38 x 38	1000	890	820
38 x 50	1100	980	900

(UNE - 136020)

BATTENS INSTALLATION

BATTENS FOR CURVED ROOF TILES

Battens will be placed parallel to the maximum pitch line, leaving the roof tile hold up between the two battens.

The distance between them will be the one that allows a minimum distance of 30 mm.

BATTENS FOR FLAT AND INTERLOCKING ROMAN ROOF TILES

The battens will be placed perpendicularly to the maximum pitch line, allowing the roof tiles to be supported over the

batten. The roof tiles must have a hole, in order to allow the nailing to the batten.

It is needed to consider the roof tiles' size in order to proceed with the right setting out and roofing tiles' support, getting that roof tiles' fitting is perfect.

Every 2 metres there should be a space between the battens so that the underside face of the roof tiles can be ventilated.

Fixing materials

MORTAR

According to job specifications and types of works: (In areas where the relative humidity is over 70% Mixed Mortar (M-40b) is used and in general Bastard (M-20b).

Cement mortar with a higher content of cements is not permitted as it dries too quickly and could produce cracks.

M-40a mortar: cement + sand = 1:6 volume
M-40b mortar: cement + lime+ sand = 1:1:7 volume
M-20a mortar: cement + sand = 1:8 volume
M-20b mortar: cement + lime + sand = 1:2:10 volume
M-20e mortar: hydraulic lime + sand = 1:3 volume

(UNE 136020)

GLUE AND ADHESIVES

The most widely used product is mastic which is applied with a cartridge-gun to clean and dry surfaces, to one of the two pieces to be joined.

The two pieces must remain in contact during the time required to set or harden. This system cannot be used at tem-

peratures below 5°C. Use according to the manufacturer's specifications.

NAILS AND STAPLES

Made of galvanised and tempered steel, and supplied with a washer for them to be secured in place using a hammer or gun. The fixing point must always be watertight sealed with mastic.

Mortars for fixing of singular points

Another point where it is necessary to give special attention is in the use of mortars for fixing of singular points, in the execution of ridge lines, intersections, eaves, and all the remaining points where one tries to fix ceramic pieces. All these points outline as critical zones in the way that an inadequate use of the mortar can put in danger the sealing

of the roof, as well as the durability of the ceramic pieces. In fact, after long periods of rain, the roof initiates a drying process, that will be more or less prolonged according to the ventilation to which it is subjected, so much in the inferior as superior face of the pieces.

IMPORTANT

All the ceramic pieces in touch with the mortar suffer prolonged moisture by the water per result of it. In them points, more easily favourable conditions are created to the appearance of micro organisms, mosses, plants, even damages made by cycles of ice - thaw (in regions with climatic propitious conditions to the formation of frosts, though these only happen during the night).

The mortar must be placed so that always it will allow the correct ventilation of all the pieces of the roof.

Eave installation. Decocurvas®

EAVE INSTALLATION

To proceed with the eaves installation and regarding the use of mortars, it is necessary to follow the same form that for the ridge lines and intersections, that means,

little mortar and preferably prepared with water-repellent specific, being applied so that always it allows the correct ventilation of all the pieces of the roof.

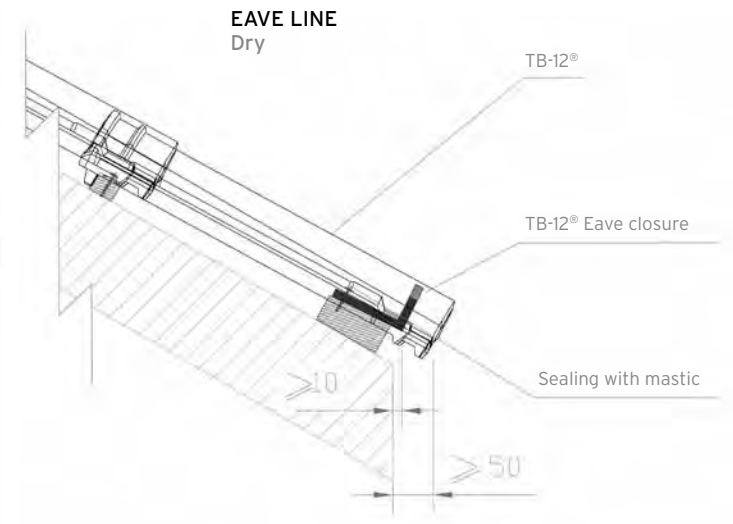
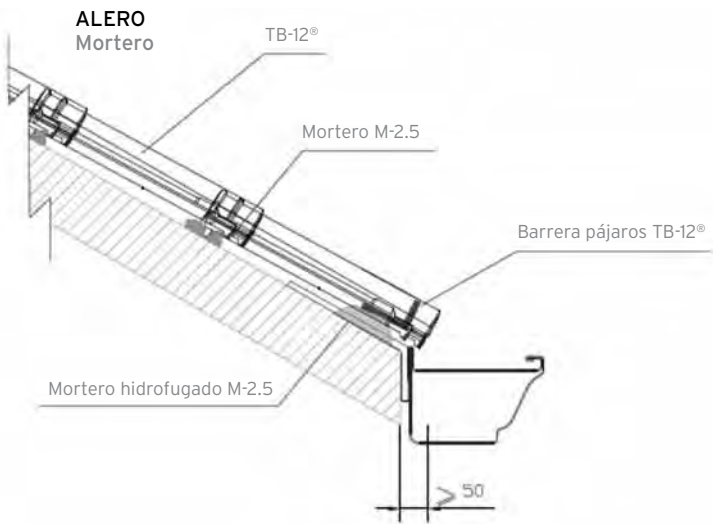

When the eaves formation is done, the first tiles must be well seated to the structure. Nevertheless it is necessary the support batten, for the tiles in the eave line, has a height superior to the height chosen for other battens.

This increase of height of the support strip for the eaves must never be lower than 2 cm.

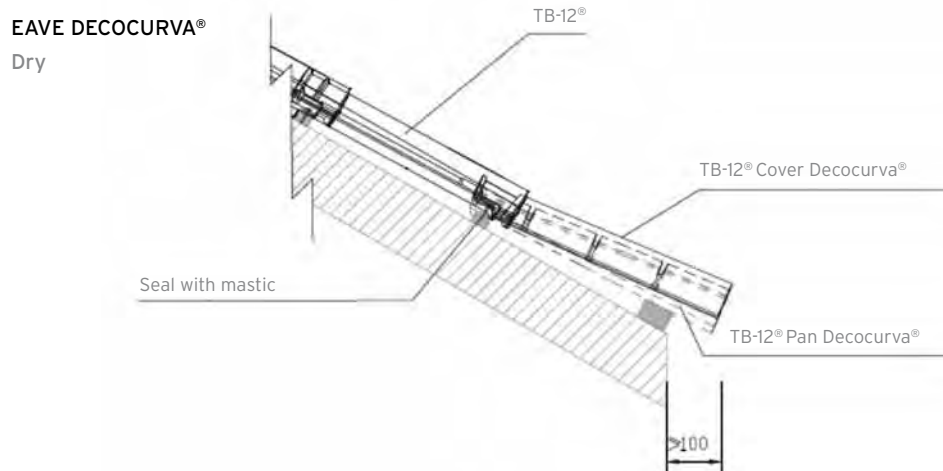

This work must be done carefully, especially if there is foreseen to use the Corner Decocurva® (set of specific pieces foreseen to finish the eaves of the roof, forming a continuous joint with the perpendicular adjacent deck).

When Decocurvas®'s placement is chosen, the distance between the axes of the ridge lines of the Decocurva® that must be respected and equal to the axes of the pan roof

tiles, as it explains in the following scheme. To avoid possible misalignment between both of them, it is suitable to obtain the distance and to try it. Once verified this distance, it is necessary to start placing first the Decocurvas® and later the ascending tiles, progressively of linear meter by linear meter, the eventual necessary adjustments being carried out. This work must be done carefully, especially if Corner Decocurvas® are used.

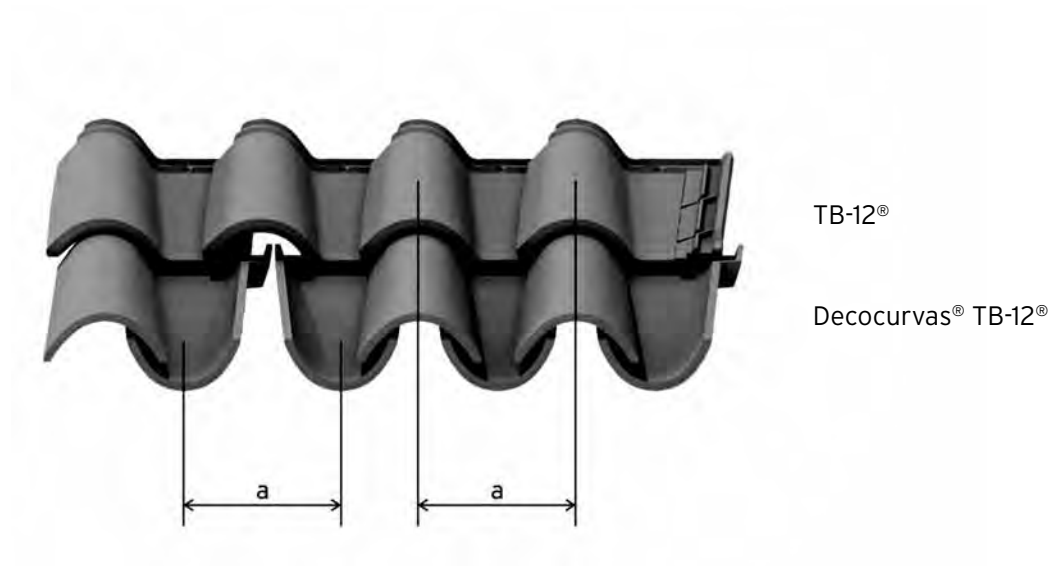

DECOCURVAS®

Installation



1. Begin with the left side of the covering, positioning the Pan Decocurva® piece with the required projection and continue in this way from the left to the right.
2. Then put the "TOP DECOCURVA® ROOF TILE" on top of the "PAN DECOCURVA® ROOF TILE" as it were a traditional curved roof tile, being both at the same level as if they are traditional curved roof tile.
3. At last, join the first line of roof tiles on top of the spoiler A from "PAN DECOCURVA® ROOF TILE" and continue placing the rest of the tiles, having the eave line solved.

Details

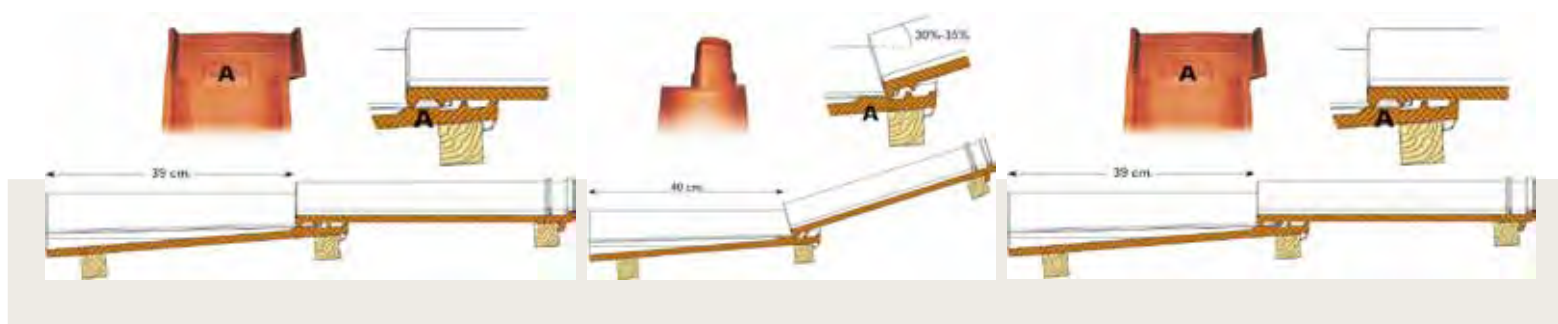

Dry fixing

The "PAN DECOCURVA® ROOF TILE" come ready made from the factory to be nailed on, by means of a pre-formed hole.

The "TOP DECOCURVA® ROOF TILE" are fixed with mastic on "PAN DECOCURVA® ROOF TILE" at the rear of the item, or alternatively secured with wires by making a hole in said support.

Variations on traditionally fitting

For this purpose TEJAS BORJA presents 5 different ways to solve the projection of TB-12® and TB-10 roof tiles, thus creating a number of finishes which up to now could only be successfully achieved with curved roof tiles.

Fitting is always approached from the technique TRADITIONAL PLACING, with small variations in the details of each system.

SEVILLA:
The Roof Tile fits over spoiler A of the "PAN DECOCURVA® ROOF TILE". Traditional fitting

RIOJA:
The Roof Tile is fitted leaving spoiler A of the "PAN DECOCURVA® ROOF TILE" exposed, this projecting from 2 to 3 cm. in respect of the "TOP DECOCURVA® ROOF TILE".

LISBOA:
The change in slope is to be handled in the same way as with the RIOJA system, with the "TOP DECOCURVA® ROOF TILE" also projecting until this is levelled off with the "PAN DECOCURVA® ROOF TILE", that is, with spoiler A exposed. The difference in slope between the "DECOCURVA®" pieces and the Roof Tile can vary from 30 to 35%, with the tile fitting into the half moon B fit formed by the "TOP DECOCURVA® ROOF TILE".

ALHAMBRA:
Fitting is the same as the SEVILLA system, placing a 40 x 19 Curved Roof Tile cut at 20 cm. under the "TOP DECOCURVA® ROOF TILE", with the latter thus forming a curve. Later on the gap left between both pieces is given a solid finish with mortar. This way it's called "BOCATEJA".

ALICANTE:
Like the ALHAMBRA system, the "PAN DECOCURVA® ROOF TILE" projects in the same way as for the RIOJA system.



SEVILLA:
Traditional.



RIOJA:
Traditional the pan tile overhanging.



LISBOA:
change of slope.



ALHAMBRA:
Traditional with solid finish.



ALICANTE:
Traditional with pan tile overhanging and solid finish.

Ventilation

(Standard regulation
UNE - 136020)

For ensuring a better durability of the roof tiles (explained in part Considerations in Characteristics of the ceramic roof tile and avoiding the condensations, it's very important foresee the proper ventilating conditions in order to guarantee the thermo - saturation (moisture) behaviour of the ceramic system.

This ventilation facilitates the process of evaporation of the rain water that is absorbed by the tile, as eventual

condensations formed downside the tile. On the other hand, this ventilation allows gradual adjustment of the ceramic piece in the difference of temperatures between interior and exterior of the roof. This way, it must be provided in its downside face of suitable ventilation. Generally, this ventilation can be ensured with the use of simple battens of mortar, with a minimal height of 5 cm. properly interrupted to equal spaces.

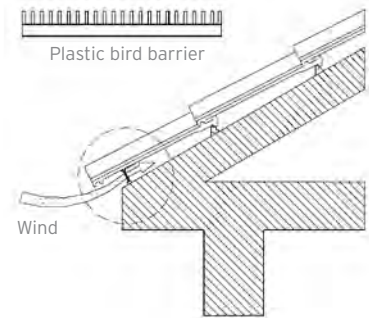
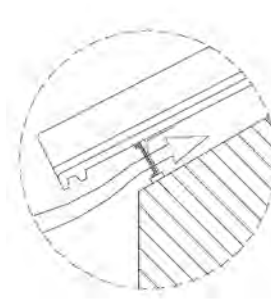
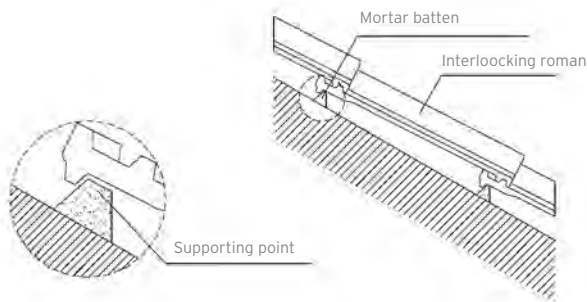

Yet the use of counter battens is more advisable to allow a space of air flow of at least 2,5 cm. In both cases, this ventilation must be complemented always with the placement of ventilation tiles, since the existing roominess between the fittings of the proper pieces is not enough to obtain the necessary air flow.

These ventilation tiles must be placed of uneven way, together with the eave line and the ridge line, so that it gets the air to cross the whole roof and there are not formed

preferential ways of air flow. If the ventilation is realized across the eave line (plastic bird barrier, eave closure) and the slopes are higher of 4 m. over the roof surface length, we recommend the placing of ventilation tiles in one or more intermediate columns, always placed unevenly in relation to the remaining ones located in the previous and posterior columns.

The use of the so called PLASTIC BIRD BARRIER is a good solution for the air inlet on the low part (eave line), at the same time as there prevents the entry of birds and rodents.

Available in three models, depending on the profile of the tile to use: LH521, LH522, LH523.

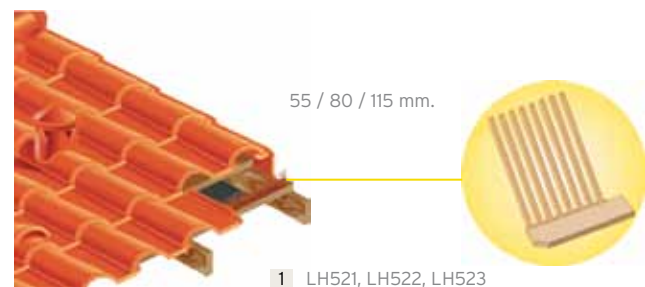

VERY IMPORTANT

To assure a good ventilation, there must be installed a minimum of 1 ventilation tile every 5 m² in case of continuous structure (fixing with mortar), and 1 tile every 10 m², in case of discontinuous structure (fixing with battens) and with a minimum of 4 tiles of ventilation by skirt, two on the lower part close to the eave line and two on the upper part close to the ridge line. A well draughty roof avoids problems of dampness derived by condensations, and destructive effects for the action of the ice.

VENTILATION ACCESSORIES

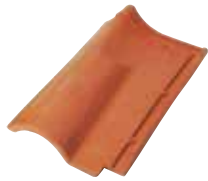

1. Ventilation roof tile



2. Chimney Carrier



3. Chimney



4. Ventilation Cap



5. Eave Closure

WARNINGS FOR EXTREME CLIMATIC ZONES

Drying effects of ventilation tiles on a frozen roof

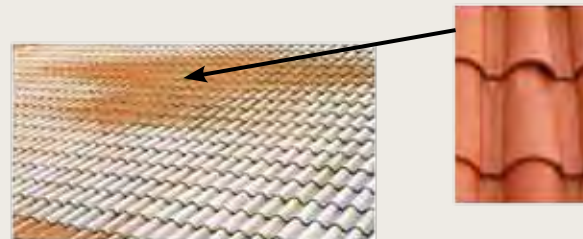

Possible negative effects for lack of ventilation tiles:



1. Condensations
(insufficient ventilation).



2. Chipping
(ice effect).



3. Fungi and lichens
(dampness accumulation).

Ridge and hip installation

RIDGE LINE INSTALLATION



1. Position the tiles on the roof deck, stopping 3 cm from behind the axis of the ridge line, and on both sides of the roof if this is a four pitch roof.

2. Position the under ridges, aligning them about 20 cm from the axis of the ridge line. Put the ridges on top of the horizon-

tal line made by the under ridges with the tiles, and ending with the end cap.

The LH-517 cross section is an optional solution. It is made of Al-Zn and flexible lead sheet folded in half with a resulting thickness of 0,5 mm.

IMPORTANT

In order for the ridge to lie correctly, it is necessary to keep to the horizontal line when positioning both the ridge tiles and under ridges.

Never close these off with mortar the ridge or the hip lines for it can cause chipping and cracks. (Figure A, B, C)

The mortar is placed so it will always allow the correct ventilation through the downside of the roof tiles.



Figure A



Figure B



Figure C

On the other hand, the excessive use of mortar or the use of very strong mortar, being this product with a thermodynamic and hygroscopic behaviour different from the behaviour of the ceramic material, can cause, in the short

term, fissures, cracks or fractures, both the mortar and the ceramic piece, appearing points of leakage of dampness and other aspects difficult to resolve.

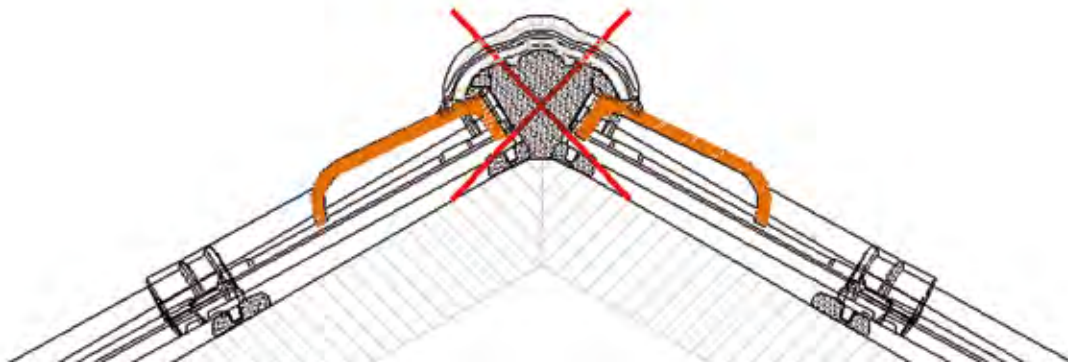

For the preparation of mortars (preferably water-repellent), it is recommended the dosing (1:2:10): for every m³ of dry sand

use 200 kg of hydraulic lime and 100 kg of cement, or, 300 kg of hydraulic lime for m³ of dry sand.

A very common mistake found in the execution of these singular points, is the use of excessive quantities of mortar to solve sealing problems, fix of the pieces, alignment of ridge line and

intersections, we recommend the use of finishing accessories in order to provide the roof with proper ventilation.

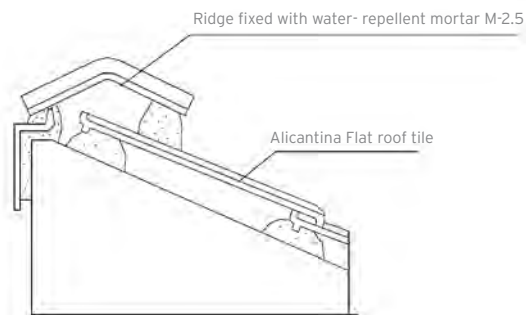

UNDER RIDGE ROOF TILE MONOPITCH
Installation with mortar

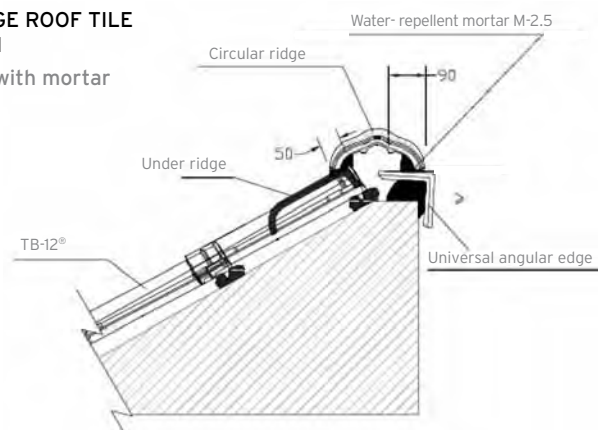

The inherent risks in this type of installation is clearly shown in page 171-Mortars for execution of singular points. In order for ridges and intersections to fulfil effectively the function to which there were destined, that is to prevent the water

leakage and to complement the ventilation of the roof make always use of the Universal Under Ridge piece, to close off the ridge line together with the tiles, proceeding as shown the following diagram.

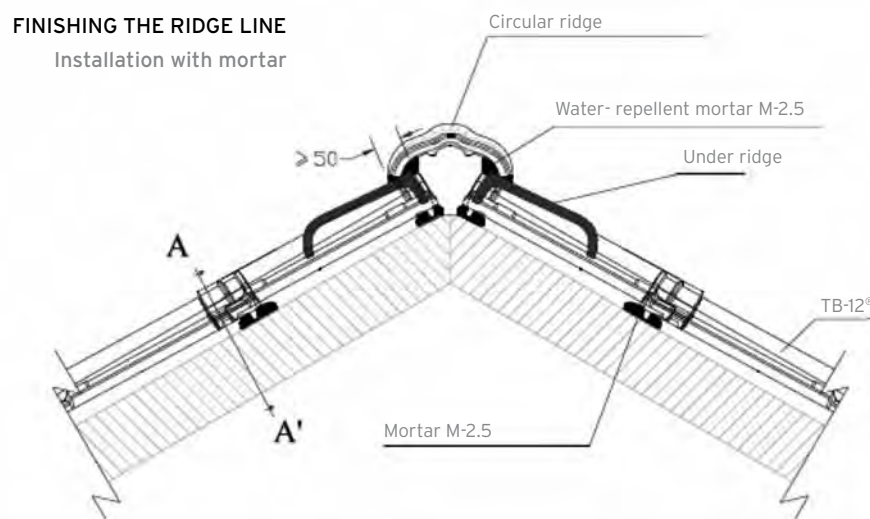

NOTE

When tiles cut is needed to finish the ridge line, it is necessary to apply, to the end of the cut tile where it will support the Ridge, a cord of silicone or mastic of polyurethane (never mortar), so that will be formed a nerve that substitutes those who were eliminated by the cut. These products (after drying) present characteristics of high durability, adherence and impermeability, being able to be used also for fixing of the Under ridge parts to the cut tiles.

In both cases, it is always necessary to get the biggest overlap possible for the execution of ridge line and intersections.

EXAMPLE OF RIDGE AND HIP ACCESSORIES

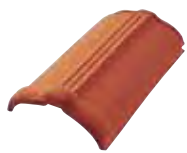

Circular Ridge



Circular Sense Change



Universal Under Ridge



Circular Hip Starter



Circular 3- Ways



Circular 4-Ways



Ornamental piece
"B" Acorn

HIP LINE INSTALLATION



1



2



3



4

1. Place the tiles on the first roof deck beyond the axis of the hip line. With a ruling pen trace a line at 3 cm. back towards the axis of the hip line.

2. Cut the tiles according to this alignment. Mark the cut tiles and remove them. Repeat points 1 and 2 for the opposite roof deck.

3. Position the end piece of the ridge and the first two under ridge about 20 cm from the axis of the hip line and to both sides of it.

4. Place the ridges and the remaining under ridges as described in point 3, until they meet with the hip line.

Edges installation



Left edge



Tile and a Half Roof Tile



Half Roof Tile



Right edge



1



2



3

1. Begin with the left side of the roof and position the edge of that side (LEFT) in an upward direction. Position the first tile so the positioning of the second left lateral piece depends on the first tile and so on.

2. The right side of the deck is completed by positioning the edge of this side (RIGHT) in an upward direction.

Position the first Half Roof Tile or Tile and a Half Roof Tile for right edge following the procedure in point 1.

3. Edges finished.

Note: The laterality for other formats will be the one that corresponds in every case.

Bibs and gutters installation

(Standard regulation UNE - 136020)

In the market there are different materials used for rain water draining. Its placement on site needs special measurement attention because on them the waters that fall down on the roof will run off. Especially in periods of intense rain, can register considerable flow rate that, not being channelled, might leak through the interior of the roof, giving problems and damages always difficult to correct. In general, the materials commonly used for this purpose are the metallic

or synthetic material bibs, even if they are self-adherents or not. Its application is commonly especially in singular points of the roof like closing off the vertical walls, finishing the edges of the roof, hip line, valleys, gutters on eave line, changes of pitches, intersections of chimneys, windows roof or any other element of the roof that interrupts the continuity of the tiles.

CHANGES OF THE PITCHES

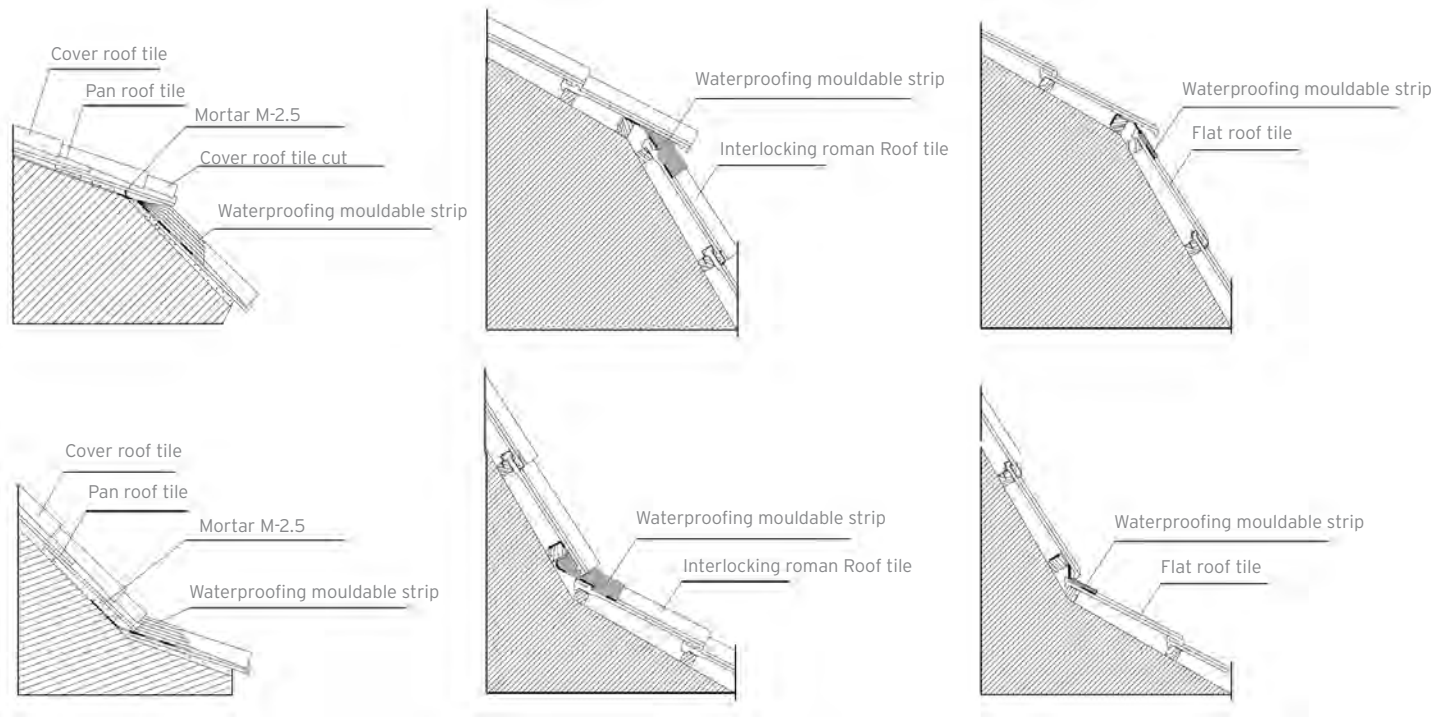

Note: The roof tiles used for the change of pitch will have to be fixed to the batten by means of lateral hooks or screws that will remain hidden in this joint.

INTERSECTIONS WITH VERTICAL WALLS

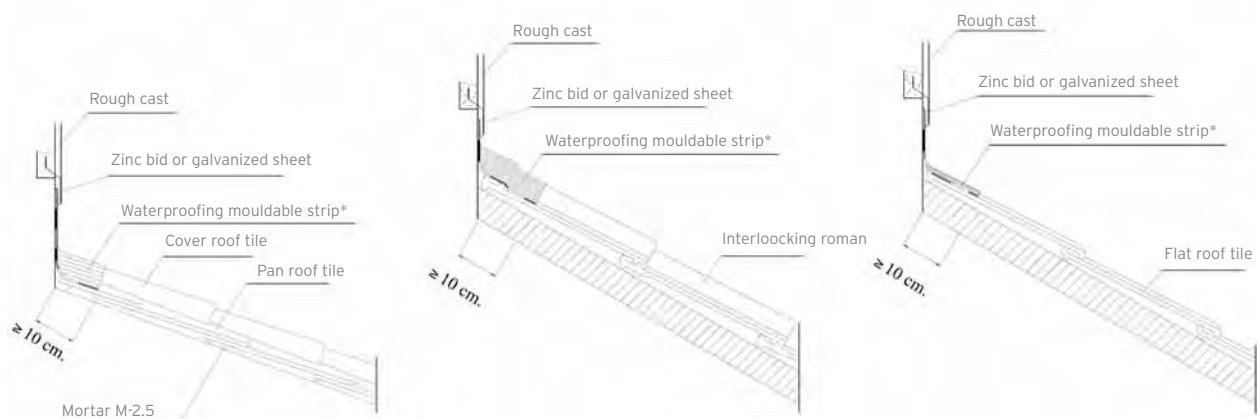

INTERSECTIONS WITH CHIMNEYS AND VENTILATION DUCTS

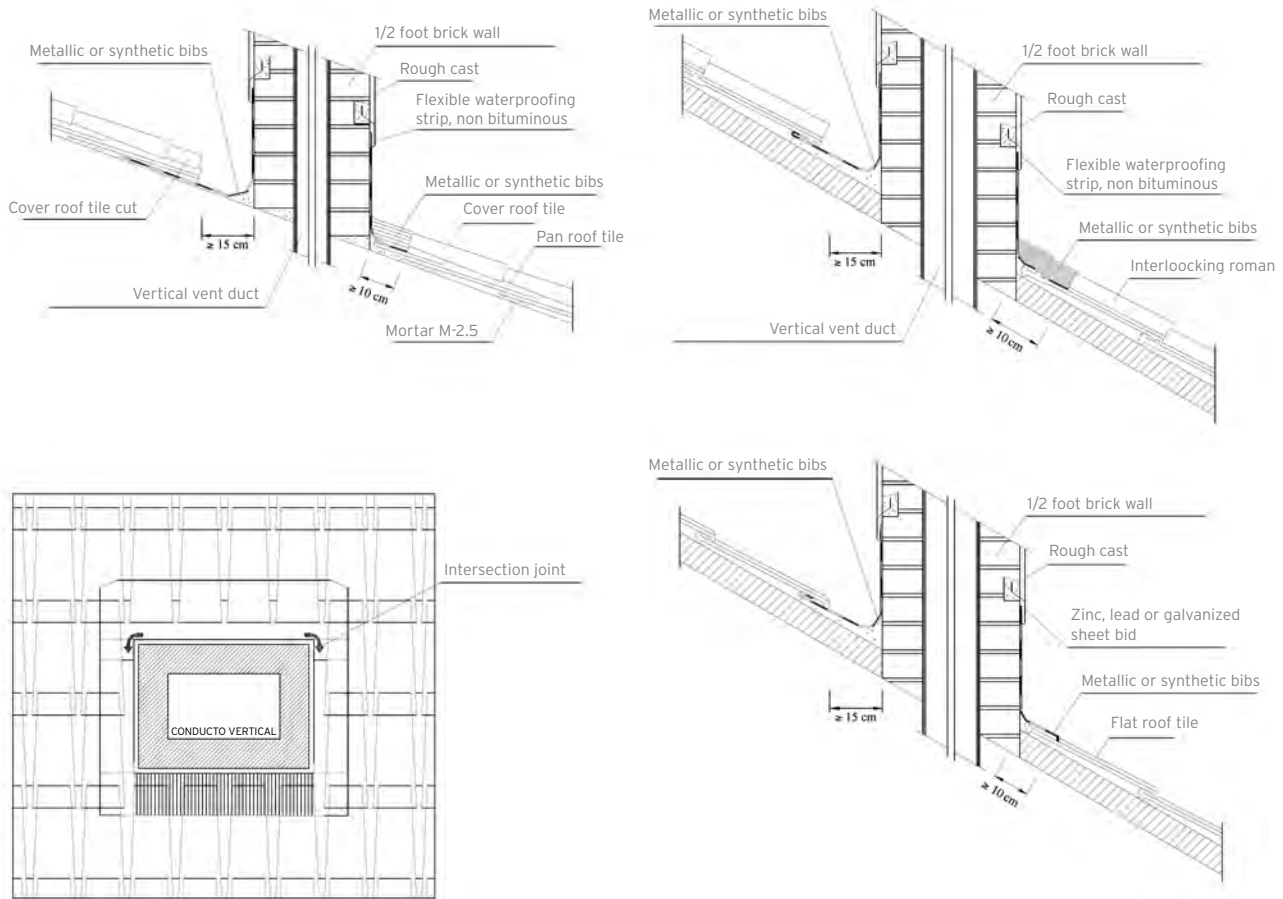

INTERSECTION WITH WINDOWS' ROOF

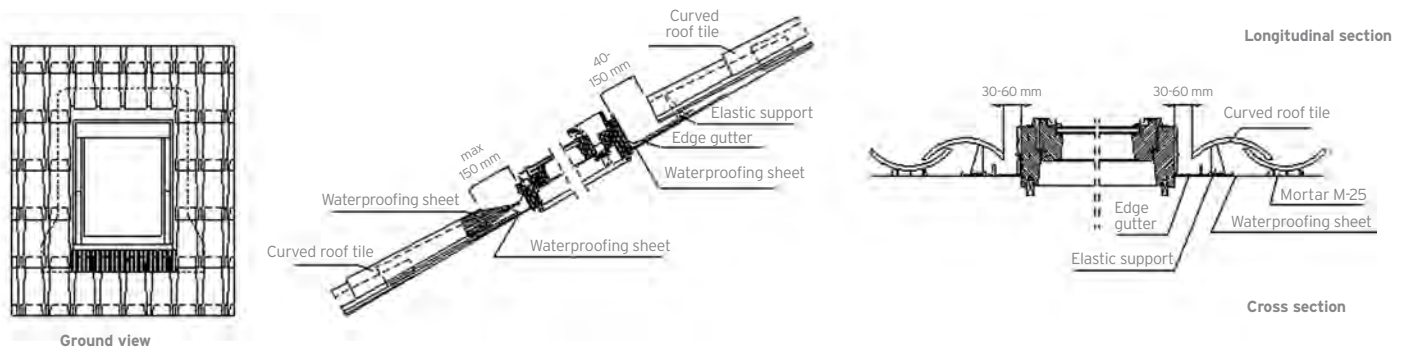

Cornices installation

CORNICES

THE RETURN TO TRADITIONAL AND INNOVATIVE TECHNIQUES

In the beginning, cornices were invented to protect facades from rain. Over time they have also been used for decorative purposes. Now GENOVA has introduced a new function, which consists of integrating the tie within the cornice. With the architectural beauty of the different decorative types available, the universality of its use in all styles and many geographical areas, GENOVA brings us the technical, aesthetic and inexpensive solution to protecting the facades of every characteristic building type.

GENOVA, A SMALL FIRED CLAY COMPONENT

Limoux cornices with integrated tie are industrially manufactured with fired clay products with a traditional look.

They are structural elements that are installed with mortar, like all building products of one, two or three overlaid courses.

At the back, the cornice has a U-shaped cavity to allow a reinforced concrete tie to be made on the tops of outside walls.

Limoux cornices are decorative ceramic elements and as such can be laid with all wall materials, ceramics, concrete blocks, concrete, and cellular concrete.

INSTALLATION

A. CORNICE

Diagram 1:

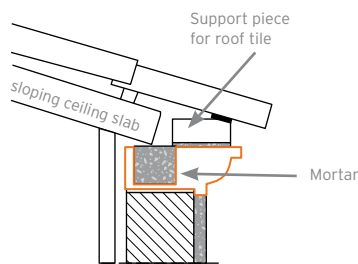

First course: the cornice with integrated tie is balanced. To be laid it must rest on a mortar joint, leaving 3 cm of its lower face visible (Diagram 1). The vertical joints can be made with or without mortar (dry fixing).

Second course: when the first course has been laid, with the tie filled in, the second course is laid, with outdoors quality adhesive cement (Diagram 2). The Unshaped chan-

Diagram 2:

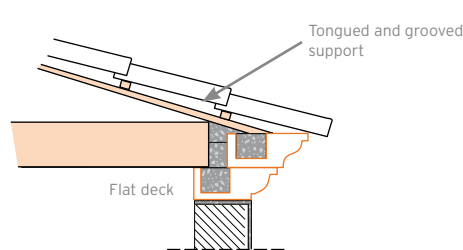

nel can be filled with concrete or waterproofed to collect water (consult) (Diagram 3).

Third course: these is possible, but consult the technician beforehand. It is laid in exactly the same way as the second course. If laying is made one course after another and the U is filled, bracing will not be necessary.

Diagram 3:

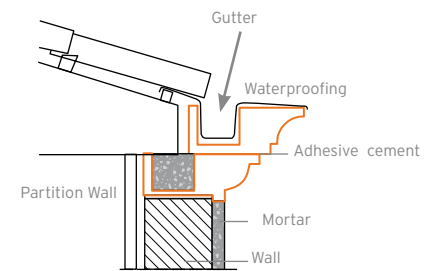

B. ANGLES

Diagram 4:

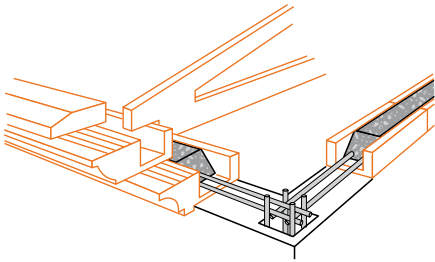
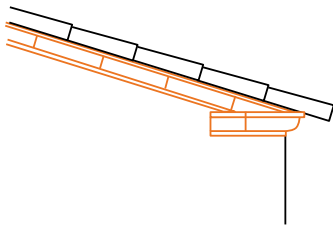

Diagram 6:



Two-sided roof, without cornice on the side slopes (diagram 4).

Connect the cornice tie with the side tie. Cover both ends of the cornice with mortar

Four-sided roof, with cornices on all facades (diagram 5)

Cut the pieces at a 45° angle; connect the right-hand piece with the left-hand piece.

Diagram 5:

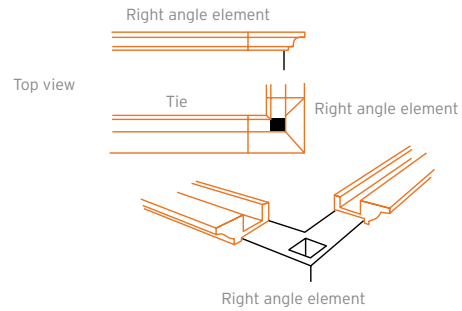
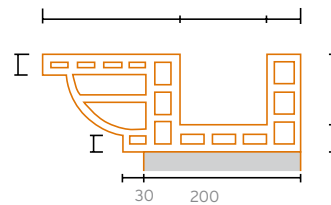

Diagram 7:



Two-sided roof, with cornices on all facades
There are two solutions in this case.

A lateral prolongation of the horizontal cornice (diagram 6). A continuation of the horizontal cornice following the pitches of the roof. Installation of all cornice models

RECOMENDATIONS

INSTALLATION OF ALL MODELS OF CORNICE

1. Cornice. One course: begin by laying the pieces at each end or corners, place the other cornices and make a small piece if necessary.

Two courses: lay them in exactly the same way, always covering the joint with the lower course.

2. Genoises. One course: begin by laying the pieces at either end or corners. If a small piece is required, half of a whole piece (tile) will be cut. If the piece is still too small, separate the neighbouring pieces slightly and join using white cement mortar. (If the facades is measured before laying the "Genoises", it can be decided whether a small piece is necessary or not. Then, depending on

the size, the "Genoise" can be allowed to fly slightly more than 13 cm if necessary). The projection is 10 cm and the support on the lower course is 30 cm (if pieces make 40 cm).

3. Cuts. Cut using a machine with water if possible, if not, use a radial cutter. In the latter case, soak the pieces in water for a few hours (they can be cut much more easily than when dry).



Catalane
(20/33x13x40)
Colours: red

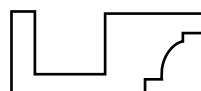

Cavet
(20/33x13x40)
Colours: red, aged red

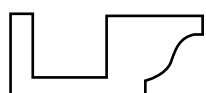

Doucine
(20/33x13x40)
Colours: red, aged red

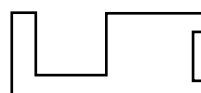

Elegi
(20/33x13x40)
Colour: red

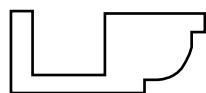

Quart de rond
(20/33x13x40)
Colours: red, aged red



Océane
(20/33x20x40)



Tolosane
(20/33x20x40)
Colours: red, aged red

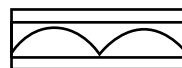

Génoise 1 course
(20/33x13x40)
Colours: red



Foraine
(20/33x13x40)
Color: red, aged red



DESCRIPTION

Dimensions in cm.: Support width/ total width x height x length.
Example: cornice 30/33 x 13 x 40 = 2.5 / Lm.

Warnings

- With slopes equal or greater to 70 % it will be necessary to fix the roof tiles by nailing or screwing.
- For slopes lower than 26 % the deck will be waterproof. Though it is possible that the local conditions could make this minimal value increase.
- Protection against the snow in powder. Any roof formed by discontinuous elements, (like tiles, slates, wood, etc.), it cannot assure completely the protection against snow effects therefore the necessary measures should be taken in consideration for this type of waterproofing.

Safety conditions on site

- Materials to be joined on top of the roof must be distributed without accumulation. When necessary, the load is to be distributed through planks or something similar.
 - Do not work near electric cables. Work will be suspended when there is raining, snowing or winds of more than 50 Km/h.
- In this last case, all materials and tools which could fly away should be removed.
- Furthermore all the usual steps applying to the general on site hygiene and safety rules are to be followed.

Difference from tonality and superficial aspects of the tiles

(Standard regulation EN 1304)

The variation of tone is understood by difference of tonality inside the same colour, and by extension, different colours in the same manufacture. For the monochromatic tiles, the variations of tone inherent in the ceramic process are tolerated according to the valid regulation, claims not being accepted for this reason.

Check always with factory before placing. Exactly, during the manufacture process of the ceramic tiles and its respective accessories, can arise light variations of tone, which, being naturals, can provide an aesthetic quite pleasant effect, taking some precautions.

IMPORTANT

Always before beginning the installation, it is necessary to mix well the different tiles that are to be use, so that, when they are placed, the different tones found will remain as dispersed as possible, giving to the roof a chromatic and uniformly harmonious aspect.

In any case, as an alternative, it is needed, as much as possible, to separate the different opposing tones found so that in every skirt the tiles will be of the same tonality or very similar tonalities.

Likewise, during the manufacture, packaging, manipulation and transport, of the ceramic material can appear in

the surface of the tiles: scratches, grazes or signs of friction not being considered together with possible folds of the clay as fault for not concerning the mechanical fundamental characteristics of the ceramic tiles: **RESISTANCE, DURABILITY, IMPERMEABILITY AND THERMAL ISOLATION**, but only it is an aesthetic aspect.

CRACKLE

(surface crackling)

The superficial **crackling** can appear in some tiles with glazed application, concerning only the aesthetics and not the structure of the tiles, by what in the Standard regulation EN 1304 it is not considered to be a defect.



BLOOMING

Some tiles can show a white thin film on the surface right after the installation, which could affect the normal colour of this surface. In most cases, it is a phenomenon of temporary blooming due to soluble salts and impurities in the water, cement and mortar aggregate which will be eliminated progressively from the surface of the piece as per the effect of the atmospheric rainfalls and it will not affect the functional characteristics of the tiles that present this phenomenon.

In any case, the own action of the climatic agents on the roof it will bring slight alterations of tonality throughout the time.

Roof maintenance

To guarantee that the roof fulfils effectively its function (described in considerations in Characteristics of the ceramic tiles), it is important to assure a proper maintenance of the roof. Actually, throughout the time, it is possible that some tiles will show fissures, cracks or fractures, even with very good mechanical characteristics that they have.

This fact owes frequently to the need to walk on the roof to proceed to the installation of equipments (antennas, air conditioning systems, solar panel installation, etc. ...) or other repairs, movement of loads, hailstorm, etc. ...



Leaves and other micro-organisms



Moss and lichen

IMPORTANT

The accumulation of micro organisms, mosses, plants and other detrituses, in the tiles, valleys and gutters, can interrupt the evacuation of the rain water and the drying of the roof. This problem will be, sooner or later, cause of water leakage.

Do not use any product that could diminish the roof tile resistance to weather conditions.

It is also recommended to check the roof and its components such as ceramic parts, insulating elements, channels of water evacuation, mortars and structure support of the roof. Providing that it is necessary, one must proceed to the substitution or repair of the damaged elements. All the ceramic pieces and channels of evacuation must be cleaned

of the detrituses and mosses that they could have accumulated, so that the drainage systems stay unblocked and dry off the waters. The CTE (Código Técnico de la Edificación / Edification Technical Code) requires periodic inspections between 1 and 3 years depending on the item. (See Table 6.1-Maintenance operations)

FAQ'S

195 FAQ's
Frequently asked questions

STANDARDS AND QUALITY CERTIFICATES

198 Applicable procedure of
certification
199 Quality approvals

Frequently asked questions

1.- Why choose ceramic roof tiles on my roof instead of another material?

Ceramic products are the result of the use and management of natural raw materials which by their nature have proven their quality over thousands of years.

They are known for their durability, high strength, dimensional stability and high performance thermal and acoustic insulation of buildings.

In the particular case of ceramic roof tiles, given their continued use over time, one can say that the roofs are coated with this material a traditional element in the landscape.

When thinking about building a house, the "roof" concept is associated with the bright colours of ceramic roof tiles, safe and durable. A ceramic roof tile roof offers added value as an element of comfort in the home, with permanent protection and additional aesthetic value.

Nowadays, although competing with alternative materials, more and more the ceramic roof tile is said to be the best solution even in northern Europe countries.

This is due not only to their aesthetic features, but their properties and performance even under the action of the most severe weather conditions.

These products are long lasting and environmental friendly.

2.- What are the accessories for, and what are their functions?

Roof accessories are complementary parts of the roof, required to solve aesthetic and functional design specifications resulting from the placement of the ceramic roof tile: the presence of accessories in a roof and proper placement is an added value for the smooth operation and durability roof.

TEJAS BORJA has a wide range of accessories for each tile model and is a leader in quality and offers the market the largest range of products, proposing solutions for most situations that can be found on rooftops. His range available enables installers to carry out, with lower costs, the work on site with minimum use of mortar, one of the main sources of problems in the roof as the accumulation of moisture and the appearance of flaking on the tiles in freezing cold areas.

3.- Why is it usual a slightly tone variation in tiles of the same type and colour?

Ceramic roof tiles are considered natural products, because the raw materials that form and get their final colour after firing, considering both the tile in his natural tone and the applying finishes.

Therefore, materials used in the manufacture of the tiles may have slightly differences in the proportions of minerals, what results in small differences in tone after firing.

The white clays, in general, are more likely to have larger variations of tones.

By applying enamels in other finishes, this phenomenon is also possible, although the manufacturing process is completely automated.

A practical way to mitigate these differences in the roof is to mix the contents of the tiles from different pallets during installation.

4.- Why is it that roof tiles condensate water drops in the bottom?

"When we found a wide open deck and in contact with the environment, by lowering temperatures in very high humidity conditions, it is easy for air to reach saturation at the bottom the side.

In this situation occurs so-called <<dew point>>, this phenomenon is about water vapour in the air condenses on cold surfaces, whether ceramic, metal or otherwise, resulting in moisture that can even come to collect water drops.



5.- Leak problems are appreciated on the roof, is this due to problems of permeability of the tiles?

Above all, we know that the ceramic roof tile is, by definition, a product that has some degree of permeability.

International standards require, as is expected, that the values of permeability are sufficiently small so no difficulties in the deck may occur.

The roof tiles certified and guaranteed by Tejas Borja fulfil all standards broadly required.

Therefore, when a filtration problem occurs is just unlikely any product liability on the tile.

In this sense, it is impossible to say what the reasons are unless a test by technical specialists is issued.

In general, the implementation problems or faulty installation of constructive encounters and the slopes are too low are the most common factors that affect the tightness of the roof.

There may be several reasons for damp in the roof:

Some moisture may show underside of the roof tiles at the time of the first rains specially if the roof is recently set.

Inappropriate ventilation is the factor with risk damp.

Because of the lack of conservation of the roof by the accumulation of organic waste in the face of the tile (accumulated dirt, leaves, debris from trees ...).

In waterproof cover (fire exits, roof window, encounters with vertical walls or any other pop on the roof ...) bad joint encounters with lateral ridges, hips and valley.

Because of an incorrect pitch setting.

Finally, an incorrect use of mortar, not allowing ventilation of the bottom of the tiles leads to accumulation of condensation.

It is recommended the roof to be checked and supervised by a roof specialist.

6 .- How to avoid humidity through the roof in my house? What should I consider regarding the ventilation of my roof?

Adequate ventilation of the roof, unthinkable, is an aspect often forgotten in homes, although it is an important factor that strongly determines its durability and efficiency.

Taking in consideration this matter in the construction stage means insignificant costs and can prevent substantially more expensive repairs in the future.

As already mentioned, ceramic roof tiles are porous and therefore susceptible to absorb and release water (known as "breath"), a quality that makes them ideal to regulate the humidity inside the building.

Good ventilation of the deck, ensuring a good setting of the roof putting special attention on the minimum air chamber, permits an easy drying of the tiles and eliminates moisture build-up inside the roof. This will improve

conservation and maintains the roof in good conditions.

It also reduces the appearance of mosses and fungi, since a well-ventilated tile retains longer the water absorbed and therefore fails to provide moisture conditions that favour germination.

7 .- Why is it so important for a roof to be properly ventilated?

Even if a roof is properly done, the humidity will have access inside.

This is a phenomenon always present and technically unavoidable; therefore, the system used for the entire roof must provide a way for the condensed water to be removed from the inner layers of the roof.

Thus, ventilation becomes the key element for that purpose, which is achieved by providing a chamber beneath the roof tiles to force airflow re-cycle through for a continuous drying process.

8 .- How many ventilation roof tiles should I put on the roof?

I must place 3 ventilation roof tiles should be placed each 10m2 in stepped course way to create a small air flow from the bottom up.

9.- I have 'moss' on my roof, how does it appear on the ceramic roof tiles and what can be done to prevent it?

The natural growing of micro-organisms (mosses and fungi) in ceramic roof tiles is commonly known as "moss."

In fact, very few materials that, when exposed, are free of this, even less porous materials, such as the glass tiles, may get moss.

As decisive factors for moss appearance the following should be considered: proximity of trees, agricultural land, building orientation, high exposure to the elements because of the topography of the area, low sun exposure (north side), air pollution, lack maintenance and ventilation of the roof, small inclination of the slopes and excessive use of mortar, among others.

The impossibility to control all these factors makes impossible to ensure that "moss" appearance in your roof is avoided.

However, there are several ways to prevent it. The ventilation of the roof is one of those, which enhances air flow and dry quickly the roof tiles after rain, which is not conducive to germination of mosses. For this purpose, the use of ventilation accessories is recommended. Special care should be put on the use of mortar since an excessive use could bring and favour humidity conditions. Another important factor to avoid humidity or water collecting points is to respect the minimum slope recommended. Cleaning and maintenance the roof every three years, depending on their location is recommended. To do this, you must remove the accumulated dirt from the roof, including gutters and all systems for water collection.

10 .- are the old curved roof tiles reusable? Do they have any warranty?

Usually the old curved tiles that we find in old building were originally handmade produced by little old local “potters” so there is no guarantee to be used in anew deck or on rehabilitation for an old one. According with the new mandatory CTE (Código Técnico de la Edificación / Edification Technical Code), if we cannot find the manufacturer of the old mentioned roof tiles and there is no documentation for them, there will be no warranty and can be used only for decorative purposes.

11.- I have spots and stains looks like a white film on the tiles, are they blooms?

The blooms are a major constructive consequences of errors committed when using water for mixing mortar or in contact with dirty items that might contaminate the water. Blooms are stains in the surface of the tile due to salts and carbonates. This situation is perfectly avoidable by taking humidity basic preventive measures. The humidity rises by capillary action and exudes from the sunniest or most ventilated areas. Water, which is mixed with other substances in solution, evaporates but not so the substances remaining in the surface of the tiles showing the problem.

12 .- My roof is being finished and some light blooming spots have appeared on the tiles. Why?

A low level of blooms is common during the execution or roof setting, although they have taken all necessary precautionary measures. Roof tiles may not contain salts (this is proofed in our products by the continuous analysis), but they can also appear in mortars or water. All these effects will come out sooner or later and it would be better if they appear during setting of the roof, because it can be easily cleaned. So our recommendation is simply wash with water and then let the roof drying until blooming stop appearing.

13.- How I can handle a case of blooming?

For roof tiles we recommend that cases of blooming were treated from the beginning by technical staff. The project and site manager are responsible for it, so it should be them the ones to decide what to do. Their procedure will surely start with a proper diagnostic of the problem and solve it, once they have ensured that it will not reappear, clean the area.

14 .- How can I change my old roof tiles?

An accurate study of the roof should be done and several important matters must be considered: The supporting structure (frame) must hold the weight of the tile (it could be heavier for the new roof tiles.) Overloading due to snow should be considered in weight parameters. Depending on the tile you choose, a minimum slope pitch should be considered. The location also should be considered following the rules and recommendations for local weather conditions. The type of insulation should be adapted as per nowadays requirements. Roof ventilation is mandatory according to the latest regulations. The length of the roof slope should not exceed the horizontal imposed by the installation rules for the new product to be installed.

We recommend you to contact a specialized company in roof coverings. As manufacturer, we can suggest you a few options according to your needs.

115 .- I want to extend on my roof, what roof tile should I choose?

An extension is like a new building in which the main structure and the necessary technical elements should be studied and prescribed by a professional under the regulations.

The choice of the roof tile is generally based on the existing model.

We recommend you contact a company to study and project this roof extension.

16 .- The tiles of my roof is no longer manufactured, what should I do?

Ceramic roof tiles have a life span over 30 years.

However, design may change.

If you have to change only a few tiles, we recommend:

Go to a store of materials and check if a current model can match your old tile.

You will easily identify the manufacturer and model of your roof tile as per the marks and codes in the back side of the tile.

If there is no chance of matching your roof tile with a new model, we recommend you remove the tiles to rebuild a full slope.

Keep the remaining tiles for further possible repairs.

17 .- Would you say that your tiles are environmental friendly?

The ceramic roof tile offers a complete range of options to respect the environment, both artistic and historical landscape through its forms, finishes and colour range.

The production of ceramic roof tile consumes less energy than other alternatives and is also a fully recyclable product, both for raw materials (composition of the clays, type of firing, CO2 emissions), and for processes production control. So we can say our tiles are environmental friendly.

Applicable procedure of certification

Tejas Borja follows the European applicable standard as for certification, named:

- **EN 1304.** *Tejas de arcilla cocida para colocación discontinua. Definiciones y Especificaciones de los Productos.*
Clay roofing tiles and fittings. Product definitions and specifications
- **UNE - EN 1024.** *Características Geométricas.*
Geometric features
- **UNE - EN 998-2.** *Especificaciones para morteros de albañilería. Parte 2: Morteros de albañilería.*
Specification for mortar for masonry. Part 2: Masonry mortar
- **UNE - EN 539-1.** *Impermeabilidad (ensayo realizado de acuerdo al método 1 y Clase 1).*
Impermeability (test made according to Method 1 - Class 1).
- **UNE - EN 539-2.** *Resistencia al hielo (ensayo realizado de acuerdo al método C y E).*
Frost resistance (test made according to Methods C and E)
- **UNE - EN 538.** *Resistencia a la ruptura por flexión.*
Resistance to the break by bending
- **UNE - 136020.** *Código de práctica para el diseño y el montaje de cubiertas con tejas cerámicas.*
Code of practice for the design and the fixing of roofs with ceramic roofing tiles
- **RP 34.02.** *Reglamento Particular de la marca AENOR para tejas y piezas auxiliares de arcilla cocida.*
Specific Rules of mark AENOR for tiles and auxiliary pieces of cooked clay.
- **RP 34.00.** *Reglamento Particular de la marca AENOR para materiales cerámicos de arcilla cocida.*
Specific Rules of mark AENOR for ceramic materials of cooked clay.
- **ISO. 9001.** System quality management. Requirements.
- **CE Mark**
- **ASTM C1167.** Standard specifications for clay roof tiles.
- **Miami Dade.** Test procedure for wind and wind driver rain resistance of discontinuous roof system.
- **DTU à Travaux de Bâtiment.** *Couvertures en tuiles de terre cuite.*
Building works. Clay roofing tiles.
- **NF063 à Referentiel de certification.** *Tuiles de terre cuite.*
Standard specifications for fired clay roof tiles.

































































































































* Check Quality approvals to page 199.

Quality approvals

All quality approvals are available on www.tejasborja.com.































































Trademarks and logos availability chart



 TB-Flat	Red					
	Brown					
	Galicia Grey					
	Leon					
 TB-4 Quattro®	Red					
	Vilaterra®					
	Fosca					
 TB-12®	Red					
	Brown					
	Cent. Ground					
	Cent. Mediterránea					
	Vilavella®					
	Rosarena®					
	Aged red					
	Jaspeada white					
	Aged white					
	Vilaterra®					
	V. Lamalou®					
	V. Bidasoa®					
	 TB-10	Red				
Cent. Ground						
Cent. Sand						
Cent. Fosca						
Vilaterra®						
Manoir®						
Fosca						
 Alicantina Flat	Red					
	Fosca					
	Litoral					
	A. Nortegna					

(Modelo patentado)

 Sólo para aquellos productos fabricados en la L32 en pasta roja.

 Celler® 50x21	Red				
	Cent. Ground				
	Cent. Mediterrania				
	V. Lamalou®				
	Vilavella®				
	Jaspeada white				
	Fosca				
	Manoir®				
	Vilaterra®				
	Brown				
 Curved 40x19	Red				
	Fosca				
	Vilaterra®				
	Vilavella®				
	Rosarena®				
	Aged red				
	Jaspeada white				
	Aged white				
	Cent. Sand				
	Cent. Mediterrania				
 Curved 40x15	Red				
	Vilaterra®				
	Aged red				
	Cent. Ground				
	Brown				
	Fosca				
	 Curved 45x20	Red			
(accessory)					
 Curved 25x12	(accessory)				



Information:
+34 902 200 909
e-mail: info@tejasborja.es

Showrooms

ALICANTE. Ctra. Ocaña nº45
03007 Alicante (Spain)
Tel. +34 965 28 50 33 - Fax. +34 965 28 89 78

VALENCIA. Ctra. Llíria a Pedralba km.8
46160 Llíria (Valencia - Spain)
Tel. +34 96 279 80 14 - Fax. +34 96 278 25 63

www.tejasborja.com

